

**Deloitte.**



Pathway to net-zero  
Mastering the twofold goal  
of decarbonization and  
profitability

Automotive



# Foreword

Disruptive times ahead require transformation in order to help secure future viability.

News of disruptive, even historic, climate change has reached into many aspects of societal, political, and economic discussion—and fundamental readjustments seem inevitable across industries. And while the target of “net-zero” is the objective within automotive, the journey depends on the ability of all industries to join forces toward achieving that common goal—and therefore, remains speculative. For example: is reaching net-zero in automotive futuristic or realistic? Scientific communities and policymakers have been able to describe workable scenarios. Even so, automotive players will likely need to recalibrate their position to move from their finite business models towards a sustainable future.

And while decision-makers may be feeling the pressure to act, the question remains: what is the right path in these uncertain times and how does it impact automakers’ current models?

In this study Deloitte Global is aiming to provide a structured and comprehensive model to help support automotive decision-makers as they answer this question. Cooperating closely with established clients, researchers, and practitioners, the Deloitte Global team identified some of the most important levers for decarbonization and achieving net-zero. We focused on scope 1, 2 and 3 emissions, taking into account the entirety of the value chain as

covered in the Corporate Carbon Footprint<sup>1</sup>. But we also considered the even deeper implications, including shifting product portfolios and changing corporate structures as well as financial impact.

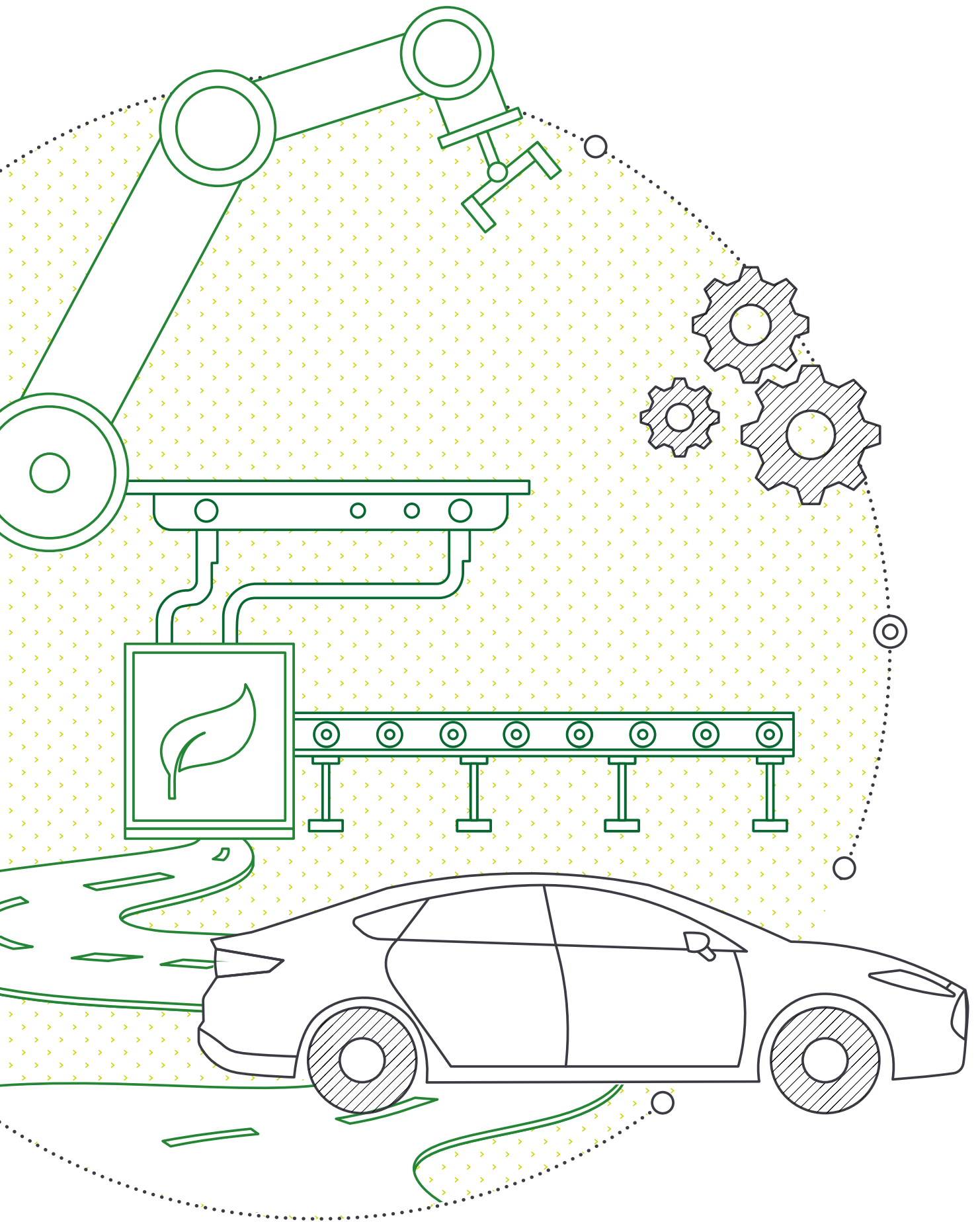
To do this we applied scenario-based modeling: we used two common climate scenarios from the Intergovernmental Panel on Climate Change (IPCC) that reflect current developments as well as more progressive developments and mapped these to three elementary behavioral paths of automotive players (frontrunner, good citizen and base case). We describe plausible developments and the impact of selected decarbonization levers, depending on the willingness to change across global markets.

Today’s sustainability decisions have massive implications to a company’s future viability. Now more than ever, the pace and impact of current climate changes call for bold action.

We hope you enjoy reading the insights and thoughts on automotive pathways to decarbonization and look forward to providing guidance in your specific transformational process to help deliver long-term emissions reduction in the most economical way possible.

# Content

Foreword	2
Executive summary	5
01. How the decarbonization challenge impacts the automotive industry	6
02. Our pathway to a net-zero model	11
03. Too little might be too late – the average OEM base case	18
04. Following the market will not be enough – the good citizen case	24
05. Only a frontrunner reaches net-zero – frontrunner results	28
06. Risks & consequences of insufficient decarbonization	40
07. Strategic moves for a successful net-zero transition	48
08. Technical appendix & limitations	54
Sources	74
Contact	76



# Executive summary

## Our study delivers following key takeaways:



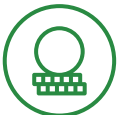
To achieve a net-zero future, early and massive investments are necessary in all areas of the value chain. These investments may cause a significant negative effect on the income statement and balance sheet of automotive players in the short- to midterm



EBIT margin will likely suffer with green transformation, but recovery is foreseeable when capturing additional market share and driving early decarbonization.



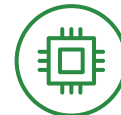
A progressive decarbonization strategy ("frontrunner") will likely lead to a gain of battery electric vehicle (BEV) market share. Rapid decarbonization is therefore the method of choice to help maintain a strong position in the market as well as to keep pace with new Chinese/Asian BEV providers.



Please Rephrase: Nevertheless, neither gains in BEV market share nor a solid current profit baseline can fully compensate for the midterm negative profitability incurred due to the high cost of decarbonization.



The leap to decarbonization will likely only be made with accessible electrification. Overall, OEMs have to quickly make the BEV product range more economical. In addition, new sources of revenue that are strongly linked to BEVs should be actively developed.



The rapid return to profitability of OEMs may be crucial for the suppliers developing the technologies needed for transformation. Otherwise, these suppliers may focus on other business areas outside of the automotive industry or file for bankruptcy due to the cost pressure in the BEV market.



A common approach and mutual support should be established between industries and regulators on how sustainable and profitable decarbonization can be achieved.

### Study structure

In **chapter 1** we provide a general overview of the challenges that the automotive industry is currently facing and emphasize the urgency to act to help achieve a net-zero future. **Chapter 2** contains a description of our net-zero model and selected pathways with decarbonization levers. The current status of our "modeled average" OEM is presented in **chapter 3**. We describe the detailed results of the two pathways of a "good citizen" and a "frontrunner" in **chapter 4** and **chapter 5**, focusing on carbon footprint, profitability, and workforce. In **chapter 6** we present the potential risks of missing out on the green transformation including the effects on market share. Finally, **chapter 7** summarizes possible strategic choices for a successful path to net-zero. Technical details and limitations can be found in **chapter 8**.

The content in this study is primarily derived from European origin perspectives. However, we do feel the messaging in this report is globally relevant for all our clients with the opportunity for regional customization.

# 01. How the decarbonization challenge impacts the automotive industry

What is the current starting point and what should the automotive sector aim to achieve by 2050?

## The automotive sector now

The automotive sector is a cornerstone of mobility systems worldwide as well as a key pillar of the global economy. However, it is also a major contributor to climate change. In 2020 alone, passenger cars and vans caused 3.5 gigatons of CO<sub>2</sub>, almost one-tenth of global CO<sub>2</sub> emissions.<sup>2,3</sup> This refers to exhaust emissions only, not considering additional emission sources along the value chain such as parts and vehicle production.

Over the past few decades, substantial improvements in the fuel efficiency of vehicles have been made by car makers. However, the growing prevalence of larger and heavier cars, mainly SUVs, and engine sizes counteracted these efficiency gains—and no amount of efficiency improvements will lead to net-zero emissions. Together with an increasing number of vehicles on the road, these factors led to a steady increase of the sector's CO<sub>2</sub> emissions by an average of 1% per year between 2010 and 2021.<sup>4</sup>

Following the Paris Agreement's target to limit global warming to well below 2°C, preferably to 1.5°C (compared to pre-industrial

levels), greenhouse gas (GHG) emissions need to reduce by 50% by 2030 and reach net-zero by 2050. The agreement has been signed by 194 nations worldwide<sup>5</sup> and its implementation requires a wide economic and social transformation.<sup>6</sup>

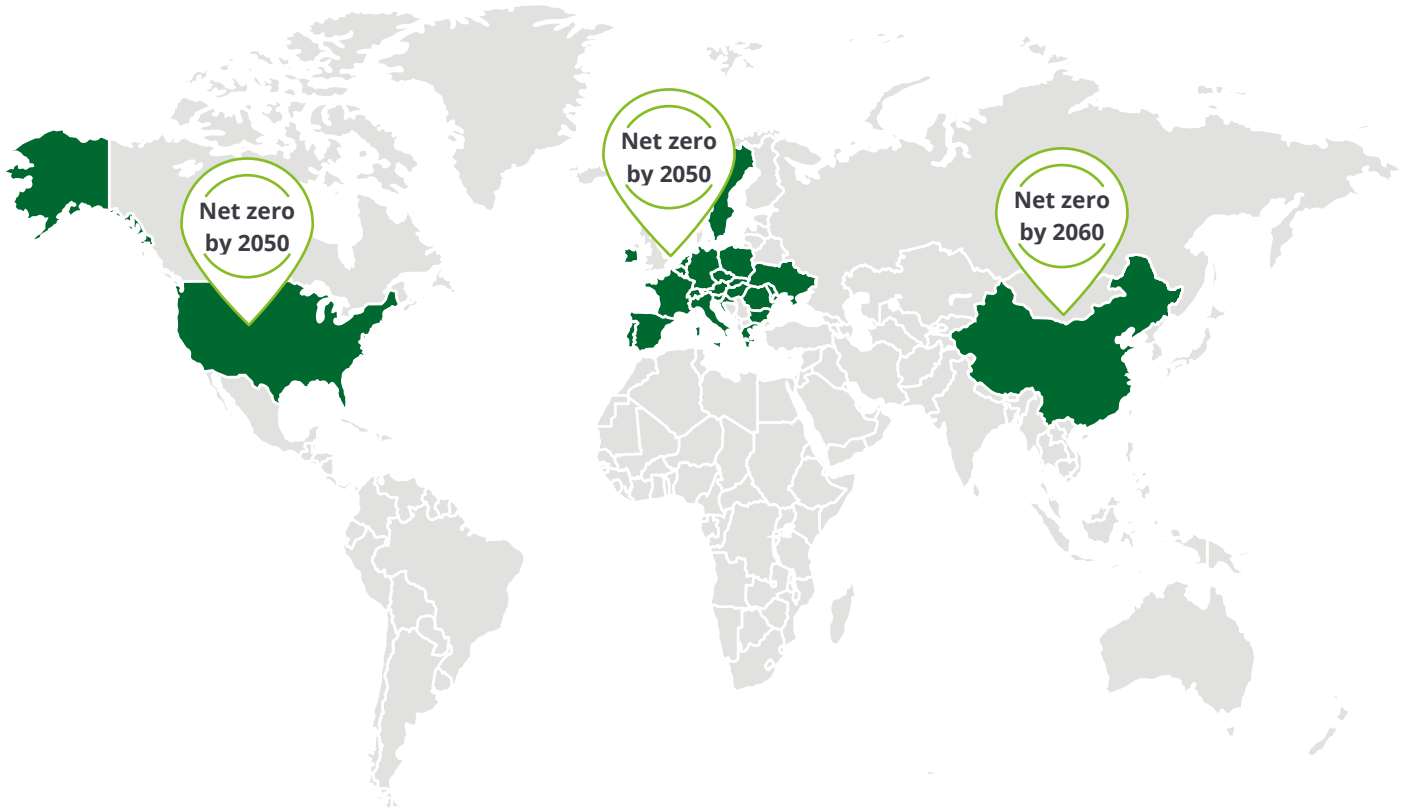
## Regulatory landscape

Transforming the global economy to achieve net-zero emissions by mid-century is an unprecedented economic challenge. To help effectively curb tailpipe emissions, governments around the globe have implemented policies promoting and enabling the shift to electric vehicles (EVs). In addition, there are other regulations such as the EU Emissions Trading Systems (ETS)<sup>7</sup> or the EU Taxonomy<sup>8</sup> that aim to reduce vehicle emissions along the entire value chain.

2022 was the first year that the overarching political framework for achieving the National Determined Contributions (NDCs) of the Paris Agreement was tightened worldwide. However, climate ambitions vary widely across countries. All countries covered in this study—Germany, the United States, and China— have set net-zero tar-

gets by 2045, 2050, or 2060, respectively, and have introduced legislation regarding the fleet emissions of newly sold passenger cars. Europe has taken the global lead in the efforts to help reduce GHG emissions. With restricting tailpipe fleet emission standards for new vehicles, the main initiative affecting the automotive industry, the European Union is planning to legislate that OEMs reduce average emissions by 55% by 2030 and by 100% by 2035 (compared to 2020). This effectively restricts OEMs to selling battery electric vehicles (BEVs) and fuel cell electric vehicles (FCEVs) from 2035 onwards. In the United States, so far only 10 states plan to phase out vehicles with internal combustion engines (ICEs) by 2050 (at the latest).<sup>9</sup> Nevertheless changes might incur locally being driven by strong state sovereignty. For several years China has promoted the market uptake of EVs. Similar to the United States, however, there is no clarity on what extent new sales of ICEs may be phased out in the future. Nevertheless, China has the strongest growing EV market.<sup>10</sup>

Fig. 1 – Regional differences define the legal environment



**USA**

- Along this way emissions shall halve until 2030, among others with a planned sales ban of new ICE & PHEV by 2050 in several US states (California by 2035)<sup>11</sup>
- Emissions-trading scheme (ETS) covering electricity production (several states) and fuels in transportation (California)<sup>12</sup>
- Use-phase emissions standards for new vehicles sold: Fleet wide CO<sub>2</sub> targets for cars will be reduced from 166 gCO<sub>2</sub>/mi (MY 2023) to 132 gCO<sub>2</sub>/mi (MY 2026)<sup>13</sup>



**European Union, Norway, Iceland**

- With the Green Deal, a net zero target by 2050 has been set and emission reduction efforts accelerated by adopting a -55% target until 2030<sup>14</sup>
- Gradual tightening of CO<sub>2</sub> emission standards for new vehicles (EU), leading to an effective ban for new ICEVs and PHEVs by 2035 (planned)<sup>15</sup>
- ETS covering electricity production (among other sectors); ETS II covering fuels (planned from 2027)<sup>16</sup>



**China**

- As the world largest GHG emitter, China has announced a carbon emission peak before 2030 and a carbon neutrality goal before 2060<sup>17</sup>
- ETS covering electricity production. China's ETS is covering more emissions than the rest of the world's carbon markets put together<sup>18</sup>
- Dual-credit system is based on two evaluation criteria: CAFC (Corporate Average Fuel Consumption) credits and NEV credits. It sets target for OEMs to collect a certain number of points<sup>19</sup>

### **Corporate Carbon Footprint (CCF)**

Describes the total amount of GHG emissions that are directly or indirectly caused by a company's activities during a reporting year along the value chain.

The GHG Protocol Corporate Standard is considered the most widely used standard for preparing corporate-level GHG emissions inventories. The standard categorizes emissions into three scopes,<sup>20</sup>

### **Scope 1**

Direct GHG emissions physically occurring at the company's sites

### **Scope 2**

Indirect GHG emissions from generation of energy consumed by the company

### **Scope 3**

Other indirect emissions from sources not owned or controlled by the company in the upstream or downstream value chain

Today's climate policies target new sales—except for some instruments that increase operational costs of petrol and diesel cars (such as CO<sub>2</sub> taxes on fuels). It remains unclear whether further regulation on the emissions of existing vehicle fleets will be introduced in the future.

### **Reactions of OEMs**

Against the backdrop of country net-zero targets, automotive companies have committed to reaching net-zero emissions by 2050 at the latest. The Science Based Targets initiative (SBTi) net-zero standard is widely used (1,669 signatories<sup>21</sup>) to offer a science-based framework for setting net-zero targets.

Currently, most OEMs are in the process of setting their net-zero targets. SBTi net-zero targets and associated decarbonization pathways are essential to verify that emissions reductions are compatible with the global goal of limiting temperature rise to 1.5°C compared to pre-industrial levels. To make their contribution, automotive companies need to reduce CO<sub>2</sub> emissions by 90% by 2050 along the entire value chain, from raw materials extraction and processing to parts and vehicle production to vehicle usage and end-of-life treatment.

Currently, OEMs are slowly shifting their portfolio from conventional ICE to BEV and FCEV in order to address their biggest bucket of usage emissions. However, it should be ensured that green electricity is used in the use phase. Furthermore, electrification of the portfolio may not be sufficient in the long term as emissions from materials, production and end-of-life may gain importance by comparison due to the energy intensive production of battery cells.



### Urgency to act

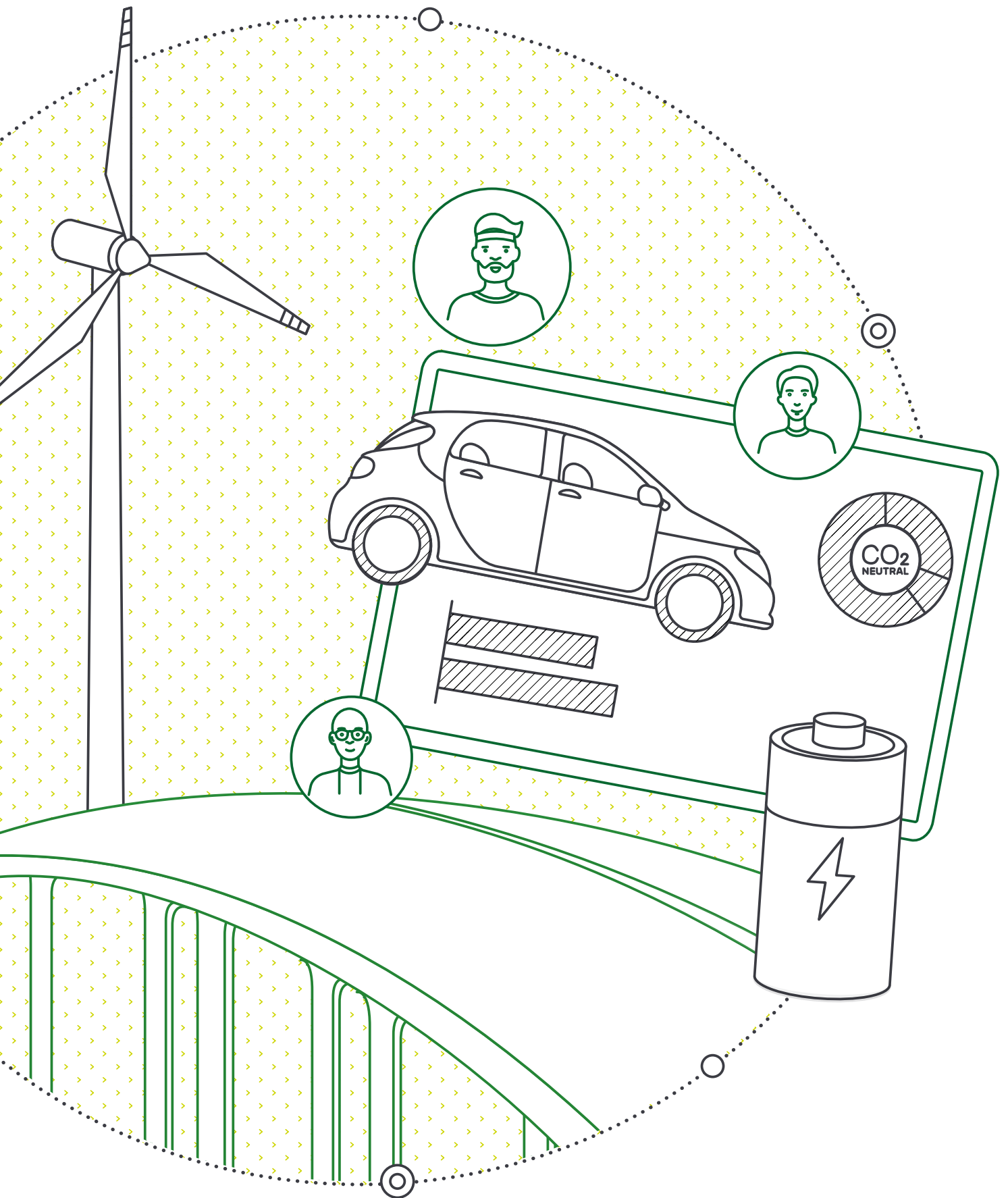
Given their traditionally carbon-intensive product, the automotive industry is especially affected by the decarbonization challenge. While the legislation increases the external pressure for sustainable transformation of the automotive sector and consumers or voters might change their behavior (e.g., voters more, consumers less), the old automotive ecosystem is complicated to transform.<sup>22</sup> The long automotive planning cycles directly impact the speed of transformation. Looking at newly registered vehicles by engine type, a movement towards electric vehicles globally is observed, with a faster ramp-up of electric vehicles in Europe and China compared to the United States. By 2021, the market share of EVs (BEVs + PHEVs) in Germany increased to 26%, while 16% of cars sold in China were electric and 6% in the United States, respectively.<sup>23</sup> As of today, the ramp-up of electrification is still hampered by several factors, such as insufficient EV charging infrastructure, higher purchase costs compared to ICEs, and insufficient vehicle supply. It is, however, important to speed up BEV market share to reach political targets—such as the goal of the German government to achieve 15 million BEVs on the road by 2030.<sup>24</sup>

OEMs know what they need to do – reduce emissions along the entire value chain by 90% by 2050 at the latest – and have set corresponding reduction targets. However, it remains unclear how the ambitious net-zero targets can be achieved in a cost-effective way, while staying on the “below 1.5°” path. To provide answers to these questions, we modeled potential decarbonization pathways to net-zero emissions for OEMs and their associated impacts on corporate carbon footprints, profit and loss (P&L), and the OEM corporate workforce.



### Science-based targets

Science-based targets are GHG reduction targets that are calculated on a scientific basis to help ensure that global warming is limited to 1.5°C. SBTs take the remaining global carbon budget to limit temperature rise to 1.5°C into account and are based on predictions about how an industry will develop in the future.



# 02. Our pathway to a net-zero model

How did we model potential decarbonization pathways?

## Pathway to a net-zero model

Deloitte Global pathway to a net-zero model used six potential pathways in two climate scenarios to compare the impacts of different decarbonization levers on carbon emissions, P&L, and workforce. Furthermore, the study models and describes an “average OEM” that is producing and selling vehicles in three exemplary automotive markets – the United States, Germany, and China – and aims to provide representative global coverage (market share development changes across time depending on the OEM behavioral path).



### Climate scenario 1 - Status quo: Continued global warming:

This scenario represents a future in which current regulations and market developments are continued until the end of the century. The world does not shift social, economic, and technological trends from historical patterns and average temperatures increase by around 2.7°C by 2100. This scenario reflects a widely adopted set of global emissions and economic and population assumptions, referred to as SSP2-4.5.



### Climate scenario 2 - Progressive: Global decarbonization:

This scenario represents a future where governments, businesses, and citizens make heavy investments into environmental technologies and change their consumption behavior to sustainable practices, referred to as SSP1-1.9. This scenario would make it possible to limit the average temperature increase to 1.4°C, staying within the bounds of the 2°C set out in the Paris Agreement.

Both scenarios were amended to reflect current regulations such as sales bans, emissions trading systems (ETS), fleet emissions, and subsidies, e.g., purchase premiums. It was assumed that regulatory frameworks do not get tightened in the future in the status quo scenario while the progressive scenario is characterized by an assumption of increased regulatory pressure on decarbonization.

This study takes into consideration two main drive trains – ICE and BEV – and five model classes – luxury, upper class, middle class, compact, and city cars.\*








There are three cases of OEM behavior—the base case, good citizen, and frontrunner—applied in both climate scenarios. In the base case, the OEM does not develop any of its own decarbonization levers and only follows market development, e.g., in the form of EV transition and energy sourcing. In the good citizen and frontrunner cases the OEM wants to achieve the net-zero target; however, their strategic approaches to implement decarbonization levers differ in mix, depth, and timing.

The good citizen follows a moderate approach to decarbonization, going beyond regulations but applying levers with a rather medium intensity. The OEM is more risk averse and shuns high investments in vague technologies. The good citizen focuses on cost-effective and established levers that are also implemented quickly and have a high decarbonization impact.

In comparison, the frontrunner takes an aggressive approach and pulls even more levers with medium to high intensity. The frontrunner represents a maximum approach to decarbonization. In addition to the levers the good citizen would pull, the frontrunner is also willing to make high investments (e.g., in the form of new technology, overcoming limited market availability, and additional R&D efforts).

**Fig. 2 – Modeled OEM behavior**

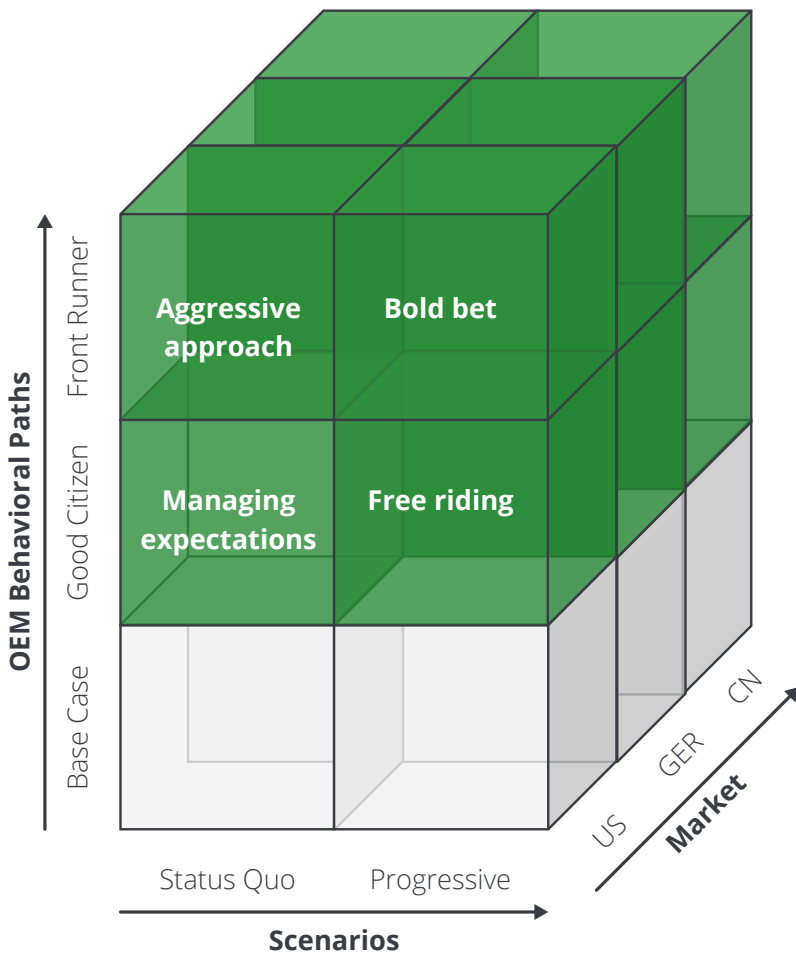
Our model is featuring three different OEM behaviours for the purpose of outlining when and how to possibly become net zero reflecting the different market scenarios.

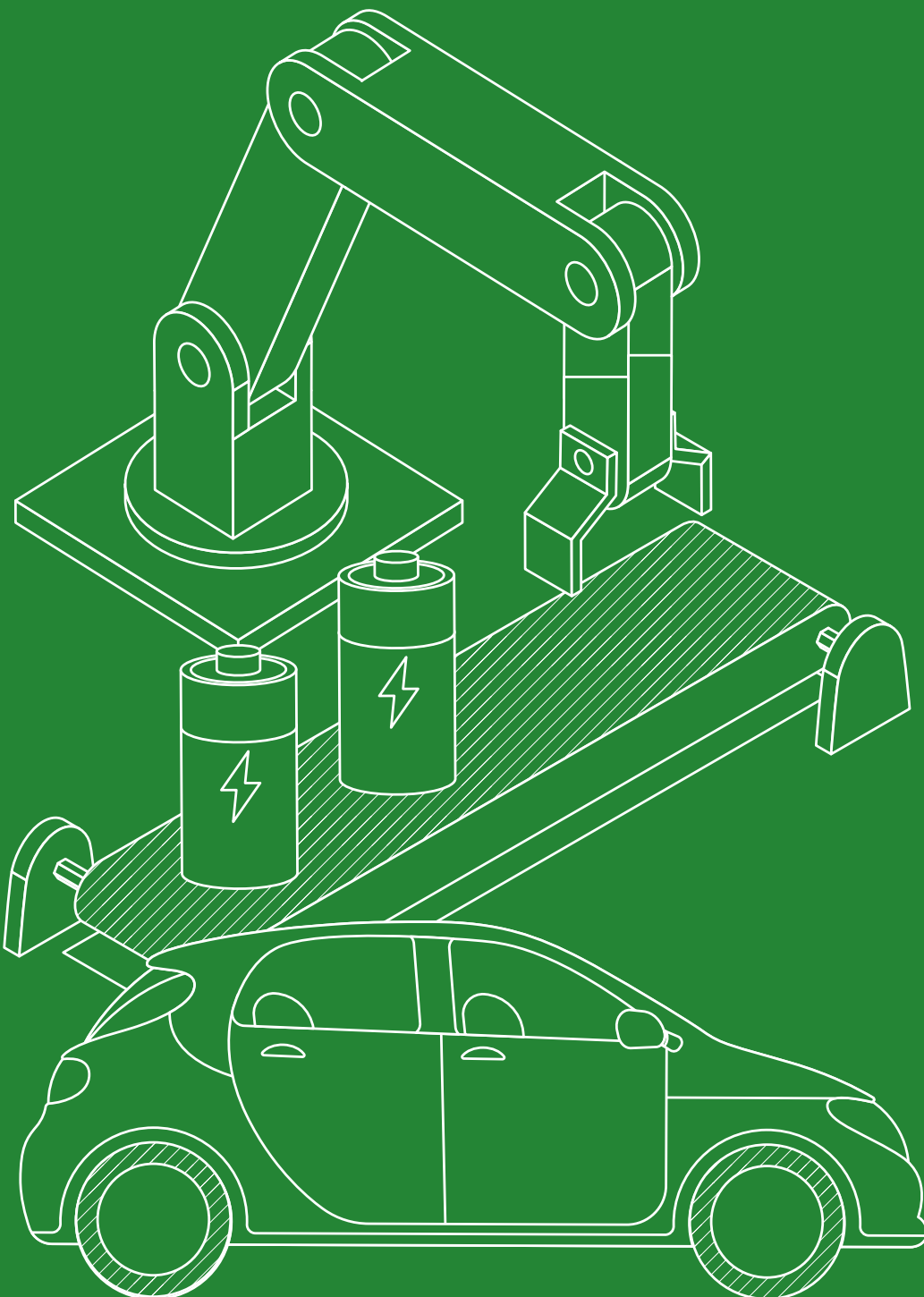
	 <p><b>base case</b> OEMs purposely await availability of technologies at scale intending to take a big bang approach to ensure conformity to regulation as soon as these are made.</p>	 <p><b>good citizen</b> OEMs follow a moderate approach to decarbonization conforming to the requirements of the CO<sub>2</sub> balance sheet.</p>	 <p><b>frontrunner</b> OEMs take an aggressive approach to be better than the good citizen because they see competitive advantages in sustainability impacting the companies financial valuation and reputation.</p>
	Focuses on serving the ICE market even though it implies high risk of losing market shares in the EV market.	Awaits general market developments and seeks a safe position for potential market scenario.	Ensures a fast ramp-down of the ICE production while investing heavily to capture additional market shares in the EV market.
	Limited ambition to drive sustainability beyond actual market developments. No active application of levers.	Applies some decarbonization levers with low intensity focusing on general market availability & market developments.	Applies all decarbonization levers with high intensity even though it requires acting contrary to general market developments.
	Does not make targeted investments to ramp-up BEV capacity, profitability highly depending on the ICE markets.	Plans for an economic ramp-down of ICEs facing the high complexity cost of managing both product portfolios and a long transition period.	Accelerate transition with targeted investments at an early stage even though it comes at increased material& production costs.
	Solely relies on general market developments without actively emphasizing sustainability impacts on workforce, clients or suppliers.	Relies on established suppliers awaiting customers demand for sustainable products trusting the existing workforce will be capable to make the transition.	Actively involves employees, customers and suppliers in the transition.

Six potential pathways were calculated, in which a base case, good citizen or frontrunner behavior is followed (See figure 3) and distinguished per climate scenario (status quo or progressive). The pathways resulting from a base case behavior represents the baseline value that is used to evaluate the impacts of a frontrunner or good citizen decarbonization approach. The possible pathways of a frontrunner – aggressive

approach in a status quo scenario and bold bet in a progressive scenario – and the pathways of a good citizen – managing expectations in a status quo scenario and free riding in a progressive scenario - will be discussed in detail in this study. For all pathways, the models give insights into their impacts on carbon emissions, P&L, and the OEM workforce.

**Fig. 3 – Pathway to net-zero model structure**

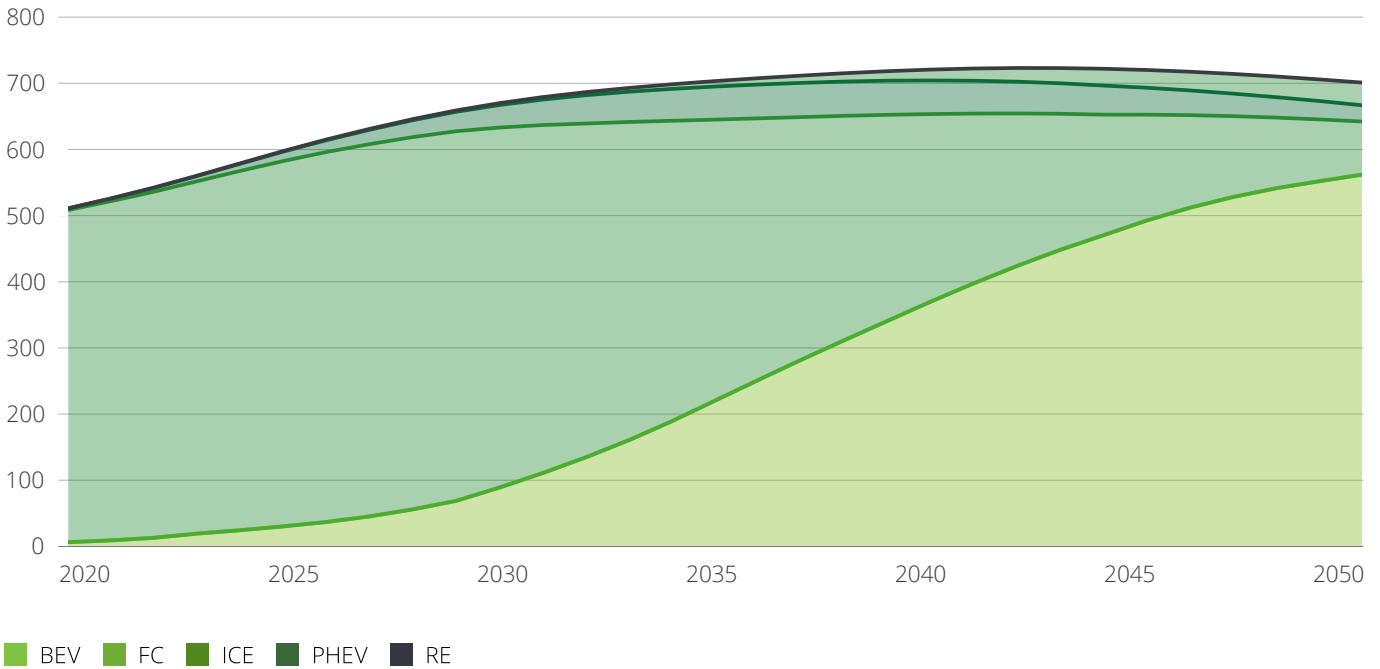




**Fig. 4 – Total vehicles in the automotive market by year (status quo scenario)**

**Vehicle market by year**

in million



**Automotive market developments**

To predict the market penetration of alternative powered vehicles in various markets, we apply a proprietary developed total cost of ownership (TCO) based forecasting tool. Our tool calculates TCO values for different powertrains taking into account more than 20 relevant factors (e.g., acquisition costs, taxes, purchase premiums, operating costs, penalties, and residual values) over an assumed usage period. By comparing the TCO values across the considered powertrains and matching them to customer preferences (surveyed in the [Deloitte Global Automotive Consumer Study](#)), a relative distribution of vehicle sales among reflected powertrains is calculated.

Based on S&P Global Mobility data<sup>25</sup> and the Deloitte E-Mobility Model<sup>26</sup>, a steady overall market (Germany, United States, and China) recovery is forecasted (after the impact of the COVID-19 pandemic and the chip crisis in 2020 and 2021) up to a

new peak of approximately 48 million vehicle new registrations in 2035. The overall market development is characterized in particular by a strong and growing Chinese market, which in our model accounts for approximately 60% of the vehicle sales in 2035. By contrast, market stagnation or even a slight decline in sales figures is forecast for the German and US automotive markets.

In terms of market transformation toward vehicles with alternative drive trains, we forecast different ramp-up curves for BEV market penetration in the considered regions. The ramp-up curves are further differentiated between the status quo and the progressive scenario. In the status quo scenario, the fastest BEV ramp-up is predicted for Germany, accelerated primarily by the EU-wide ICE ban, in place from 2035 onwards. After an initially slower shift towards alternative drives, the BEV ramp-up in the Chinese market will likely

be accelerated significantly from 2030 onwards by rigorous regulation, with an ICE ban starting in 2045. While the BEV ramp-up in Germany and China is mainly characterized by sales restrictions on ICEs and decreasing prices for electric vehicles and a strong local BEV industry in China, the US market is developing more slowly in the direction of BEVs.

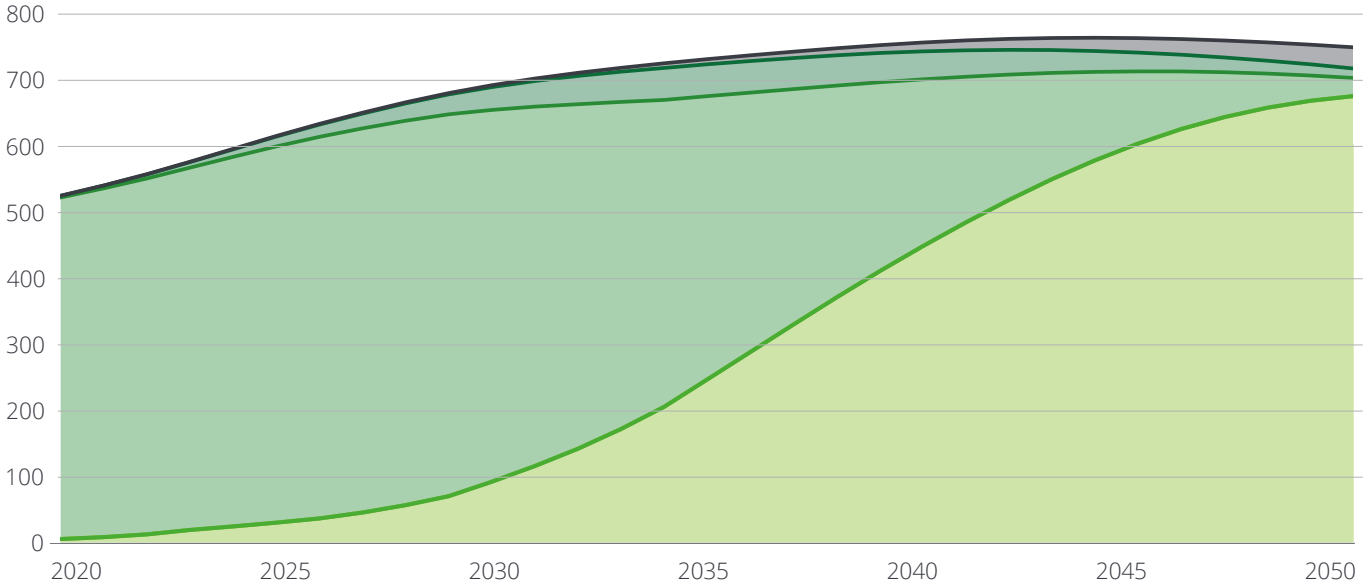
In contrast to the status quo scenario, BEVs are expected to penetrate the market much faster from around 2030 onwards in the progressive scenario. While the regulatory framework in the considered markets should remain virtually unchanged until 2030, a higher carbon price in ETS for fuels used in transportation as well as earlier ICE bans across the considered regions may lead to a significant acceleration of BEV market penetration after 2030.



**Fig. 5 - Total vehicles in the automotive market by year (progressive scenario)**

**Vehicle Market by year**

in million

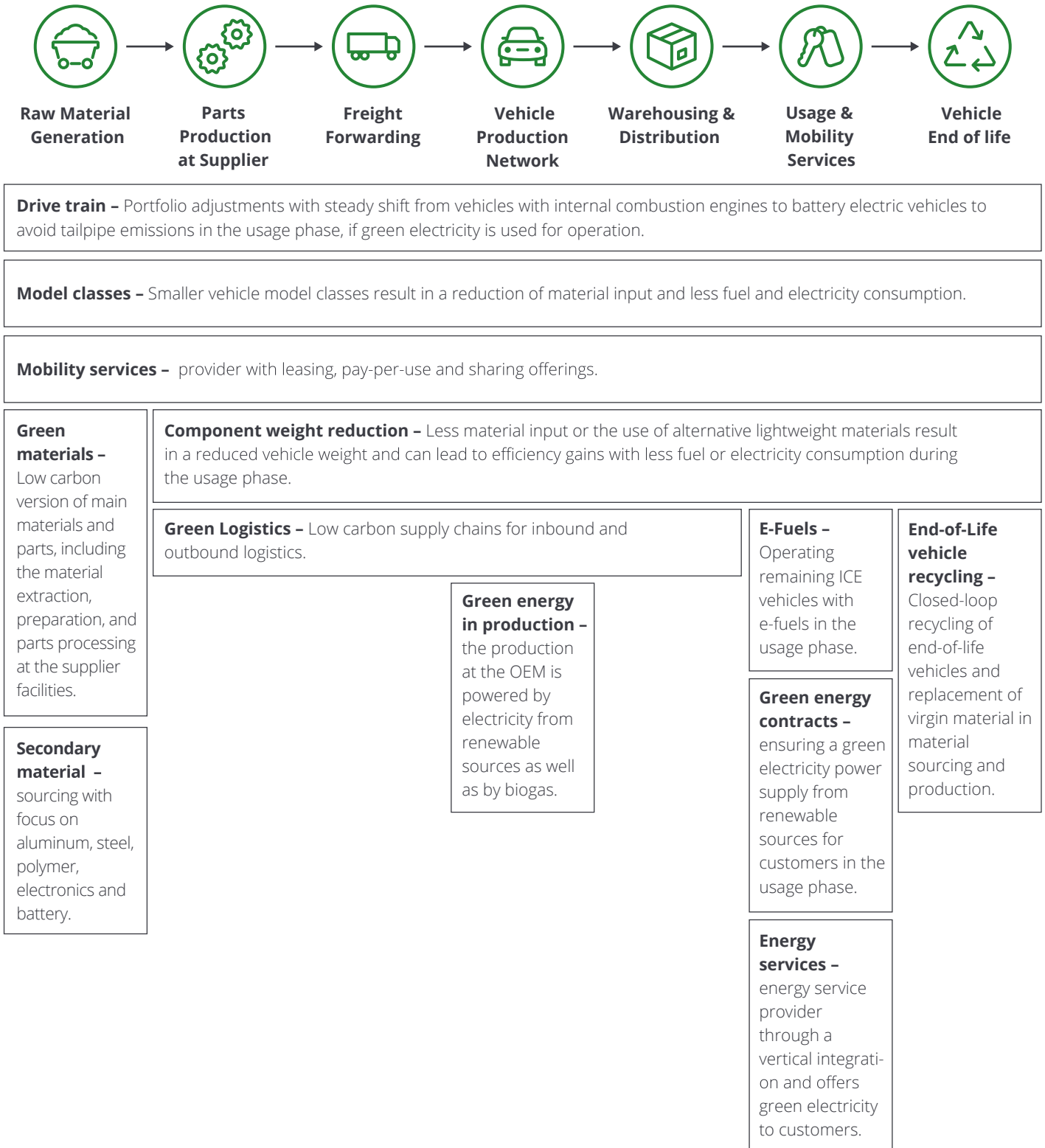


BEV FC ICE PHEV RE

**Main decarbonization levers**

There are relevant decarbonization levers for OEMs to reach net-zero emissions. The levers' carbon impact also depends on their interactions with one another. For example, applying the drive train shift as a lever to decarbonization is not that effective if not paired with green energy contracts in the usage phase. Only when both levers are combined can they realize their full potential.

**Fig. 6 – Main decarbonization levers across the value chain**



Pulling the listed decarbonization levers in Figure 7 can immediately impact the OEM's carbon footprint, P&L, and their workforce. Reflecting the developments of these areas over time, opportunities and challenges in the chosen pathway can be identified, which will be described in the following three chapters.

### **Model output: carbon emissions, P&L, and workforce**

In order to help differentiate the effects of decarbonization for companies, the pathway to net-zero model provides relevant outputs as they pertain to carbon emissions, P&L and the OEM workforce.

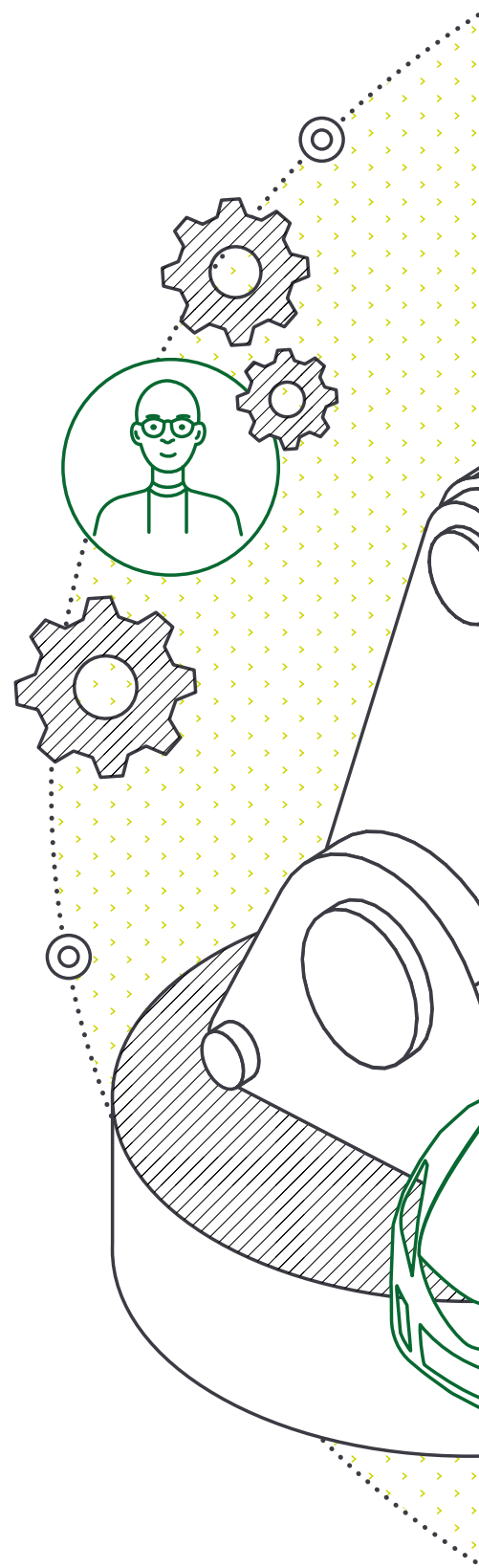
The corporate carbon footprint (according to the GHG Protocol<sup>27</sup>) of the OEM consists of the four main emissions areas: materials, production, usage, and end-of-life treatment.

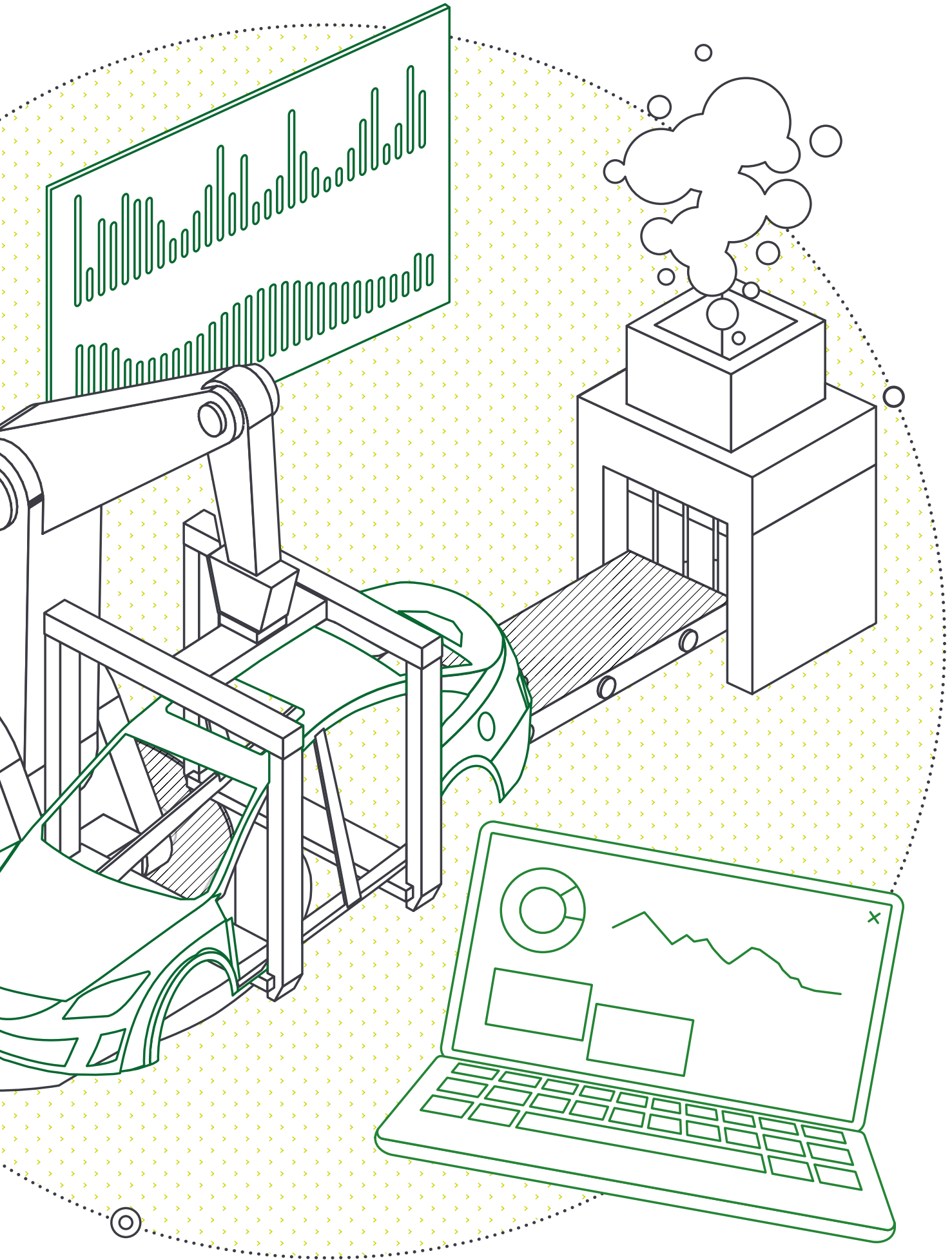
For P&L, the four main revenue streams - vehicle sales, after sales, used car sales and leasing - were considered with their respective shares.<sup>28</sup> For costs, the following main costs of goods sold (COGS) categories are represented: material, production, personnel, logistics, and other. Depreciation for leased vehicles and for production assets were considered as well. Moreover, costs for research and development (R&D) as well as for other sales, general, and administrative (SG&A) activities were included in the P&L.

The OEM workforce is based on an average distribution of employees along the following departments: R&D, sourcing, production, sales, HR, finance, IT, and customer service.

# 03. Too little might be too late – the average OEM base case

What happens to an average OEM not actively decarbonizing?





### Average OEM in 2022

The average model OEM, as modelled for the scope of this study, operates with a market share of 5% each for BEV and ICE in United States, China and Germany in 2022. The OEM sells five different model classes – luxury, upper class, middle class, compact and city cars producing in total 1.9 million cars in 2022 and does not shift between the segments during the transformation time.

**Note:** The modeled average OEM does not represent a volume or premium OEM, but an OEM with a certain market share. If required, the model could be tailored to volume or premium OEMs. Based on the assumed price structures, the premium OEM would have a different sales margin compared to a volume OEM. In effect, due to the current high cost of batteries, it is harder to reach profitable electrification in the volume segment compared to the premium segment.



### Carbon emissions

The OEM's activities – as modeled for the scope of the study - in 2022 led to 111 million tons total CO<sub>2</sub>e in scope 1, 2, and 3, with 6% in scope 1 and 2 and 94% in scope 3. Usage emissions represent the greatest single emissions category with nearly 80 million tons and 72% of the entire OEM CCF. To achieve the target of SBTi net-zero emissions, the OEM must reduce its CCF by 90% by 2050 compared to a base year. The base year for the OEM net-zero target is set to 2018, with 152 million tons total CO<sub>2</sub>e, to avoid the COVID-19 dip distorting the baseline.



### P&L

The OEM has an EBIT of 7% in 2022. The top line comprises 68% vehicle sales, 16% leasing, 11% used car sales, and 5% after sales. In terms of sales revenue, the cost of goods sold (COGS) make up about 71%, depreciation 6.5%, R&D 4%, and other selling, general, and administrative costs, 11.5%.



### OEM workforce

The OEM in 2022 has about 124,000 employees of which ~40% work in production, ~27% in R&D, ~10% in sourcing, ~5% each in HR, finance, and IT, ~9% in customer service, and ~4% in sales.

**Fig. 7 – The average OEM in 2022**

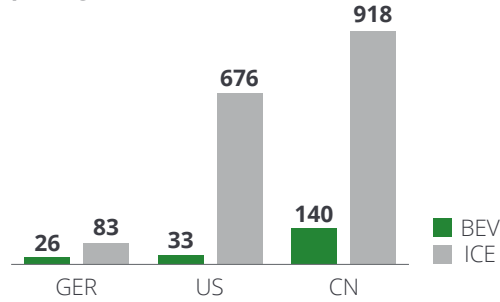
The average OEM ...



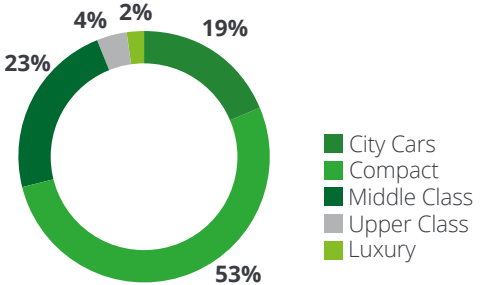
**Market**

... operates in three markets (US, China, Germany)  
 ... had a market share of each 5% of the BEV, ICE and PHEV in the US, China, Germany in 2021  
 ... produced about 1.9 million cars in 2022

**Produced cars in 2022 per region (thousand)**



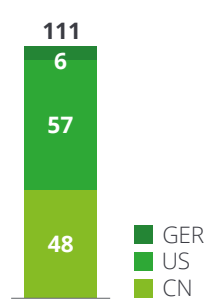
**Vehicle classes distribution of produced cars in 2022 (%)**



**Emission**

...produced 111 mio. tons CO<sub>2</sub>e emissions in 2022

**Emissions Footprint 2022 (in mio. tons CO<sub>2</sub>e)**



**P&L**

...had an EBIT of 7% in 2022

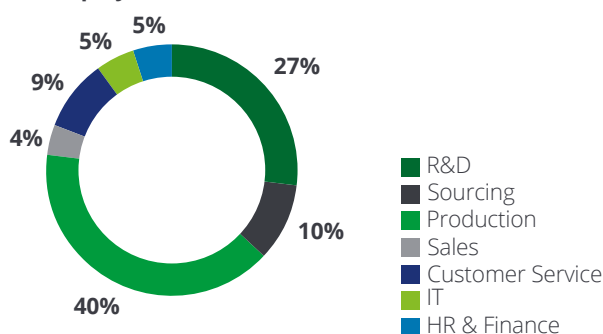
<b>Profit &amp; Loss (Base Case)</b>		<b>2022<sup>1</sup></b>
<b>Sales/Revenue</b>		<b>100%</b>
Costs of goods sold – Material		48%
Costs of goods sold – Production		14%
Costs of goods sold – Logistics		1%
Costs of goods sold – Personnel		6%
Costs of goods sold – Other		2%
Depreciation & Amortization		6.5%
R&D Costs		4%
Other selling, general, and administrative costs		11.5%
<b>EBIT</b>		<b>7%</b>



**Workforce**

...had about 120,000 employees spread over several departments in 2022

**Employee Structure (%)**



<sup>1</sup> Sales/Revenue: consists of vehicle sales, leasing, used car sales and after sales.

What happens when the average OEM does not develop any of its own decarbonization levers and only follows regulatory and market developments? This represents our base case in both the status quo and progressive scenarios, against which other case pathways are evaluated.

### **Base case decarbonization pathway results**

In both base case pathways, baseline status quo and baseline progressive, the OEM remains focused on ICE vehicles and only behaves in a compliant manner with regulatory requirements. The market shift to BEV and regulatory developments will likely conclude in decreasing production levels in the end, putting the OEM out of business.

In numbers, the overall vehicle production of the average OEM significantly decreases from 1.9 million vehicles in 2022 to around 800,000 in 2050. In the Baseline Status quo, the OEM manages to maintain its 5% market share of ICE until 2050 but loses its initial 5% share in the EV market. In the Baseline progressive, with an assumed ICE ban in China, the OEM is restricted to the US market.

Considering market-driven downsizing, it is not surprising that the OEM manages to reduce emissions by 85% in 2050 compared to the target base year 2018 (baseline status quo). In effect, the EBIT margin turns negative by 2040 and the OEM workforce diminishes to 70,000 employees in 2050. This, in turn, leads to a decline in market share and will likely put the OEM out of business in the long run.

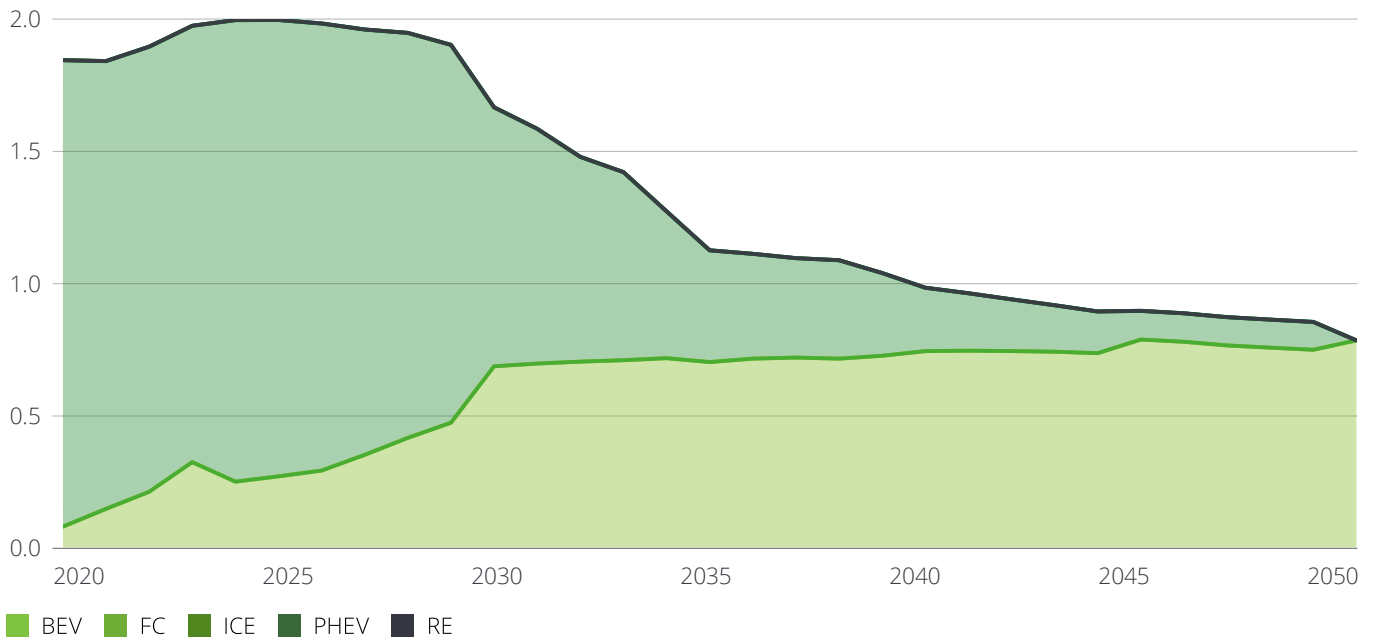


**Fig. 8 - Overall vehicle sales (Germany, United States, and China)**

**baseline status quo**

**Total OEM vehicle production by year and fuel type**

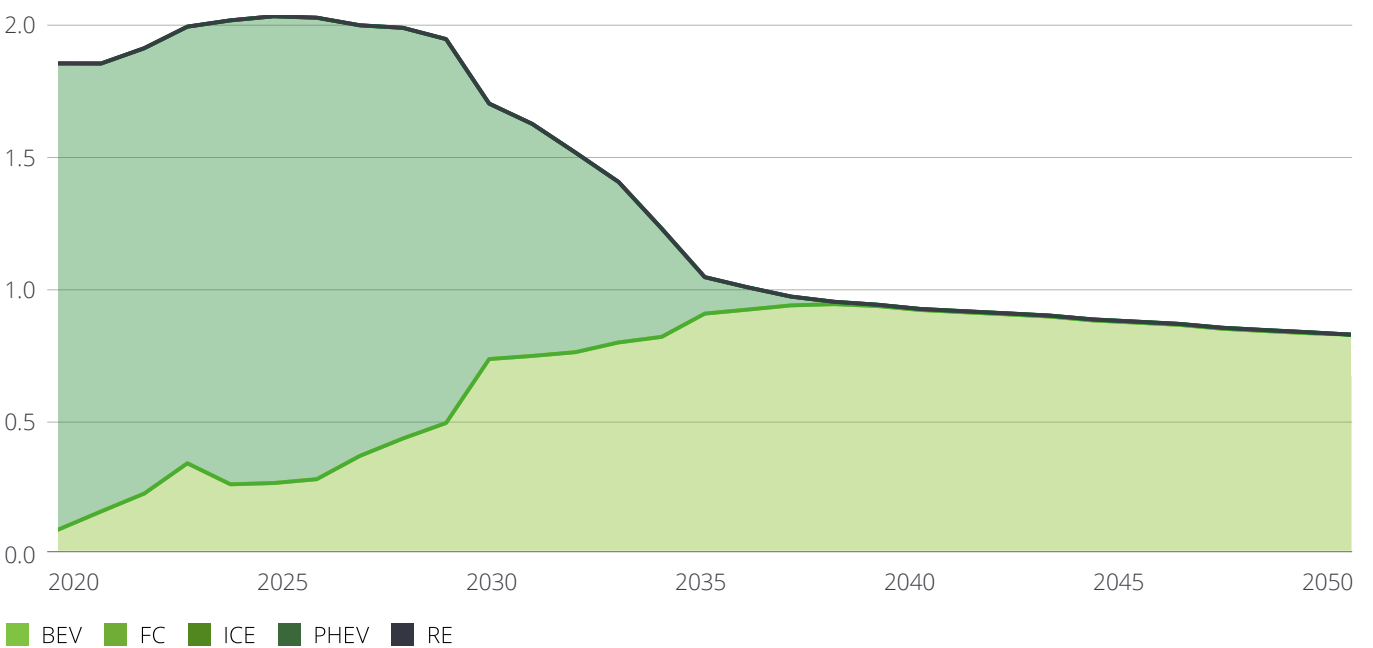
million vehicles produced



**baseline progressive**

**Total OEM vehicle production by year and fuel type**

million vehicles produced



# 04. Following the market will not be enough – the good citizen case

What are the impacts of being a good citizen?



## Impact on carbon emissions

An OEM characterized by the behavioral profile of “the good citizen,” i.e., who is only “going along” with regulations, may not be able to reach net-zero. By being a good citizen in the status quo scenario and managing expectations, the OEM also manages to reduce emissions. Herein the good citizen will pull the decarbonization lever if the market conditions are convenient, following a slower approach with lower intensity compared to the frontrunner. However, the reductions are not sufficient to reach net-zero as the OEM is left with 14.5% residual emissions in 2050. Cumulative emissions from 2018 to 2050 are reduced by only 0.4%, as compared to the base case.



## Impact on vehicle production

The good citizen with the “managing expectations” pathway manages to maintain its total market share of 5% by gradually replacing ICE with BEV market share. However, due to the lack of drastic transformation in prior years, the OEM does not manage to secure a higher additional share of the growing BEV market, which grows to 39 million vehicles in 2050. As result, the good citizen only manages to keep its vehicle sales constant at about 1.9 million vehicles across time and ceases to grow.



## Impact on P&L

### Earnings before interest and taxes (EBIT)

The good citizen OEM may mainly stay profitable during the coming years with its managing expectations pathway but its slow shift to BEV and the high costs for the electrification will likely lead it to a stagnant market share and declining EBIT rates. Especially until 2030, the declining ICE vehicle sales and shrinking vehicle margins will likely become noticeable for the good citizen with a significant EBIT drop (see Figure 9 (1)). To overcome this trend in time, the revenue from other sources such as BEV sales and leasing can help. It should be considered that in terms of vehicle margin, EVs need leasing in the short term, as they are less profitable at first, but their prices and costs will likely stabilize in time due to economies of scale (see Figure 9 (2)). Nevertheless, the slow transition from ICE to BEV will likely cause higher complexity and ramp-down costs as well as a longer pay-back period for the good citizen. After that, the EBIT margin should continue to grow (see Figure 9 (3)).

**Fig. 9 – EBIT development for good citizen (managing expectations) [in %]**

**EBIT margin by year**

EBIT as share of revenue in percentage



The good citizen case might seem to appear attractive as a strategic management approach but only on a short-term or midterm horizon and in a status quo scenario. As OEMs need to plan and act in accordance with their corporate vision and mission, this approach would not conform to goals that work to gain sustainable growth.

### Impact on workforce throughout

As shown in figure 10, the total number of employees of the good citizen OEM will likely decrease to about 107,000 employees (Managing expectations).

The drive train lever influences the OEM workforce, especially affecting the production and customer service departments. The production workforce is assumed to decrease, as about 8% fewer direct production workers are needed to produce a BEV compared to an ICE (e.g., for assembly). Further, the customer service department will likely transform due to less maintenance but increasing leasing contracts. BEVs typically cause higher battery maintenance; however, the overall maintenance for BEV can decrease by about 15% due to about 25% fewer parts as compared to ICE. An opposite effect is assumed for leasing: the “new” business model may lead to additional workers for the provision of mobility services, e.g. subscription contracts. Also, the R&D departments will likely increase due to the product IT and BEV ramp-up. The workforce is forecasted to have an assumed productivity increase of 0.8% per year until 2030 and 0.4% until 2050 for various departments except production, where a constant decrease of 0.8% p.a. is assumed. This has a direct effect on the total number of employees. However, the impact of the behavioral pathways and external developments shown in this model will likely only have minimal impact on sourcing, sales, IT, HR, and finance.

The shift to sustainability and the resulting effect on the workforce is not only about the total number of employees but also a complete change in production processes and the development of new technologies. Additionally, there are differences in skills, tasks, and workers required to build BEVs as compared to ICEs. About 80% of the skills required in the short-to-medium term to help achieve net-zero emissions by 2050 already exist. But the shift to connected and electric cars requires new skills, which is why current workers are likely to require upskilling.

Moreover, various departments, including procurement, finance, and sales are impacted by sustainability decisions as the transformation will likely affect the entire workforce by changing the skill profiles and requirements for work.

### Good citizen in a progressive world

In the progressive scenario, the OEM might choose to rely on the efforts of favorable market development. However, even if the world develops towards sustainability, the OEM cannot reach net-zero emissions with a free riding pathway along with market developments and only being a good citizen (13.5% residual emissions in 2050 compared to the absolute emissions in the selected base year). This implies that the market will emphasize sustainable developments, in effect providing better market conditions for decarbonization. With identical good citizen behavior, the OEM can reduce emissions faster and at a greater scale than in the status quo scenario but not to a level that is sufficient for net-zero. Cumulative emissions from 2018 to 2050 are increased by 5.4% compared to the baseline case progressive.

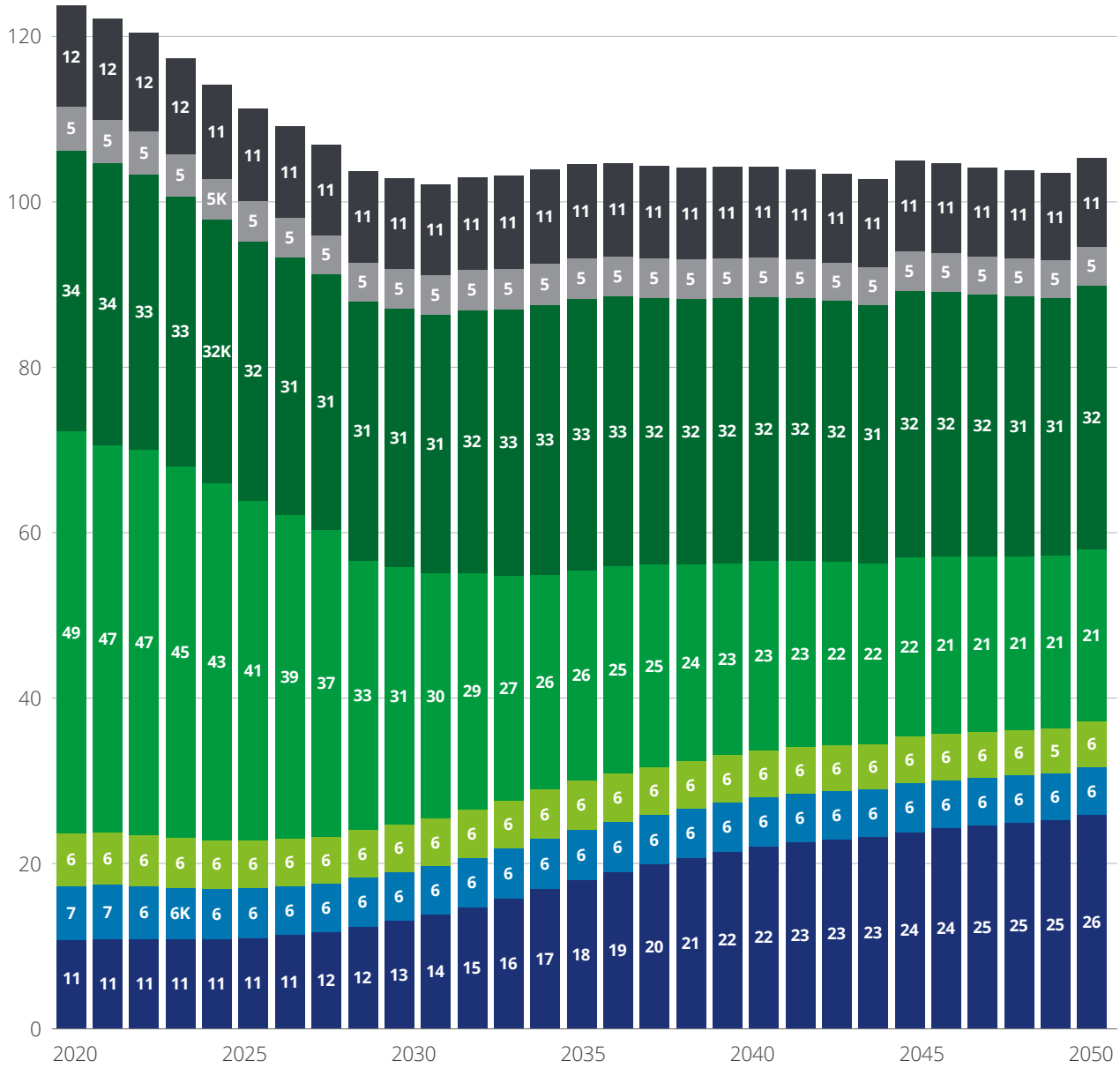
Vehicle numbers and workforce results show no substantial difference within the managing expectations pathway. The main difference lies in the significantly lower as well as negative EBIT margin without recovery in time in the free riding progressive scenario due to stricter climate regulations regarding fleet targets and higher carbon pricing on, e.g., conventional materials and energy sources, which are still used in the coming years.

An accelerated decarbonization strategy is necessary for OEMs to reach “net-zero” in 2050 – simply “going along” will likely not be enough.

**Fig. 10 – Forecast workforce development good citizen status quo scenario**

**Total workforce by year**

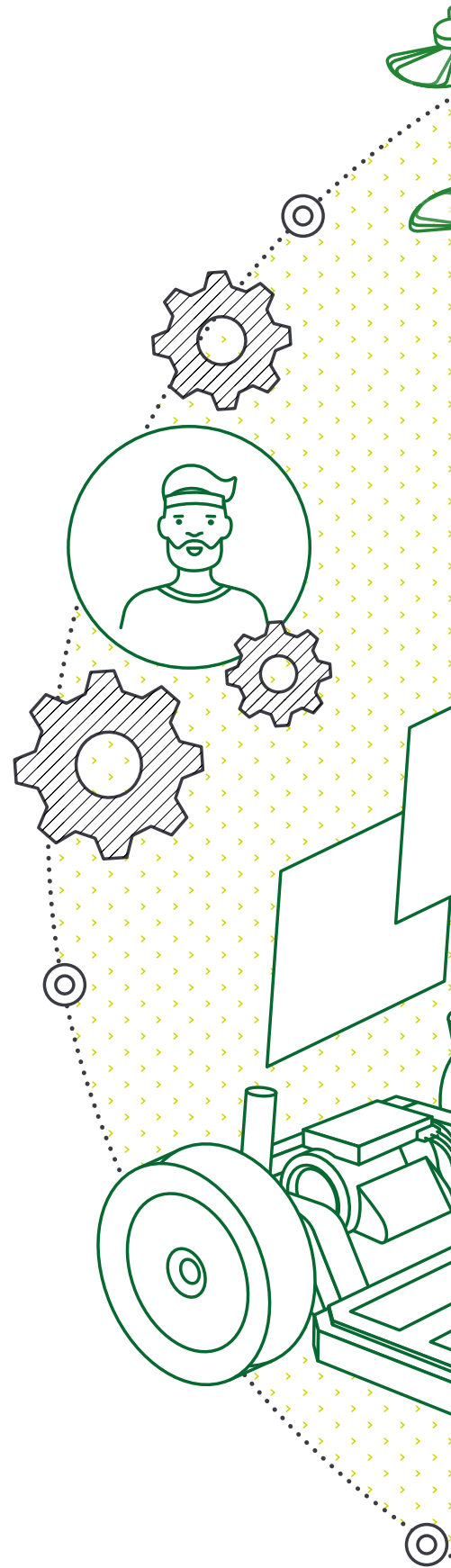
Number of employees in thousand

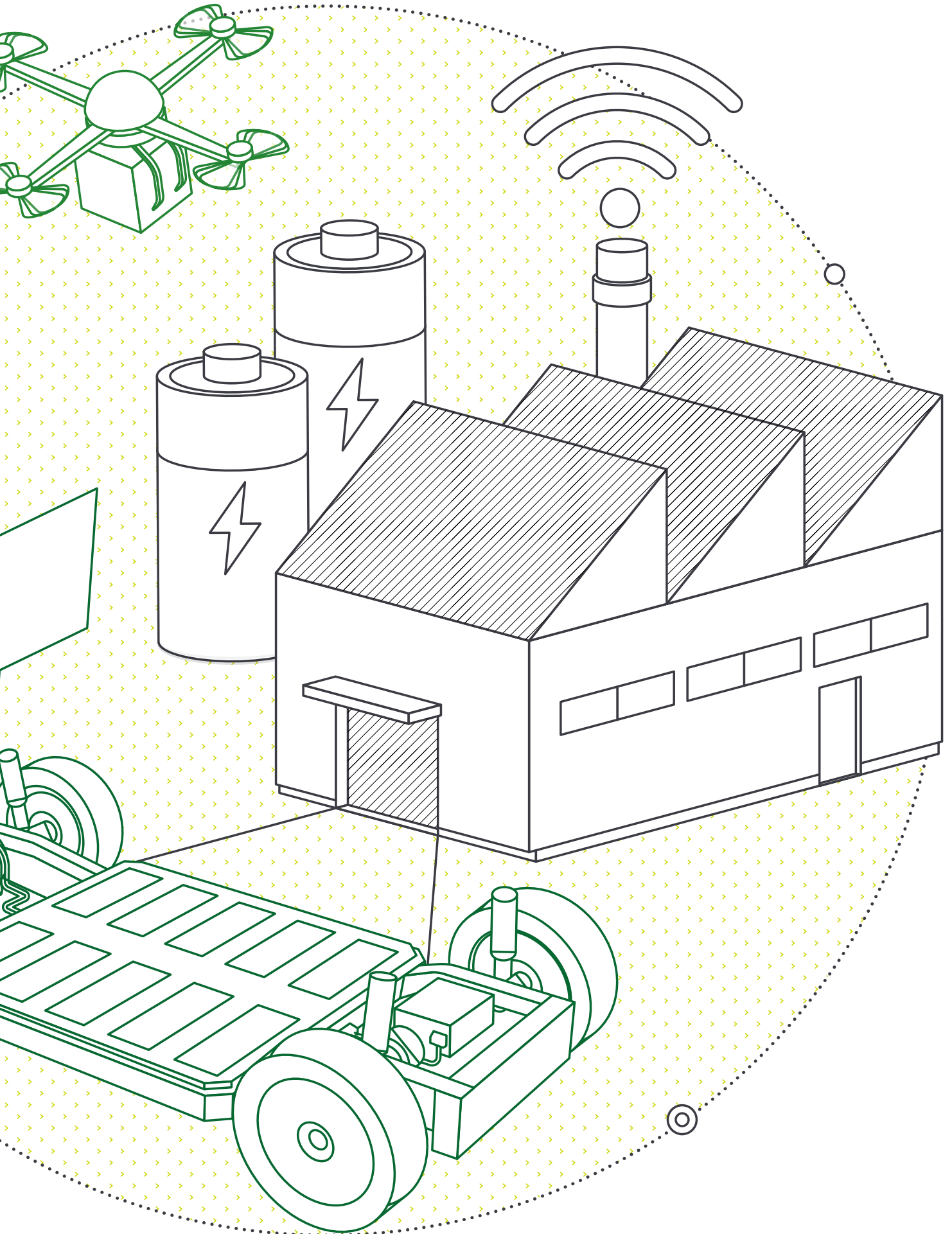


- Sourcing
- Sales
- R&D
- Production
- IT
- HR & Finance
- Customer Services

# 05. Only a frontrunner reaches net-zero – frontrunner results

What can a frontrunner achieve?







### Impact on carbon emissions

In contrast to the other behavioral pathways, being a frontrunner can likely guarantee that the OEM reaches net-zero emissions by 2050. In the aggressive approach the OEM manages to reduce its emissions to 6.4% residual emissions in 2050. Usage emissions are lowered by switching to BEV and ensuring green electricity along the entire value chain (materials procurement, production, and usage) and investing in circularity.

After 2030, material emissions rise through the increased procurement of carbon-intensive batteries and become the main decarbonization hurdle. In 2050, 76% of the

residual emissions stem from purchased materials. Over the entire target timeframe (2018 to 2050), the frontrunner emits 1.73 gigatons CO<sub>2</sub>e, compared to 2.14 gigatons CO<sub>2</sub>e of in the base case OEM. Considering their vastly different sales development (growing versus shrinking) trajectories, this reduction is a lot more impressive. In total, the cumulative emissions are reduced by 19.2% compared to the baseline status quo.

This carbon emissions reduction of the aggressive approach pathway, shown and summarized in figure 12, runs below the SBTi cross-sector reduction line. The OEM is therefore compliant, reaches net-zero emissions, and contributes to limiting global

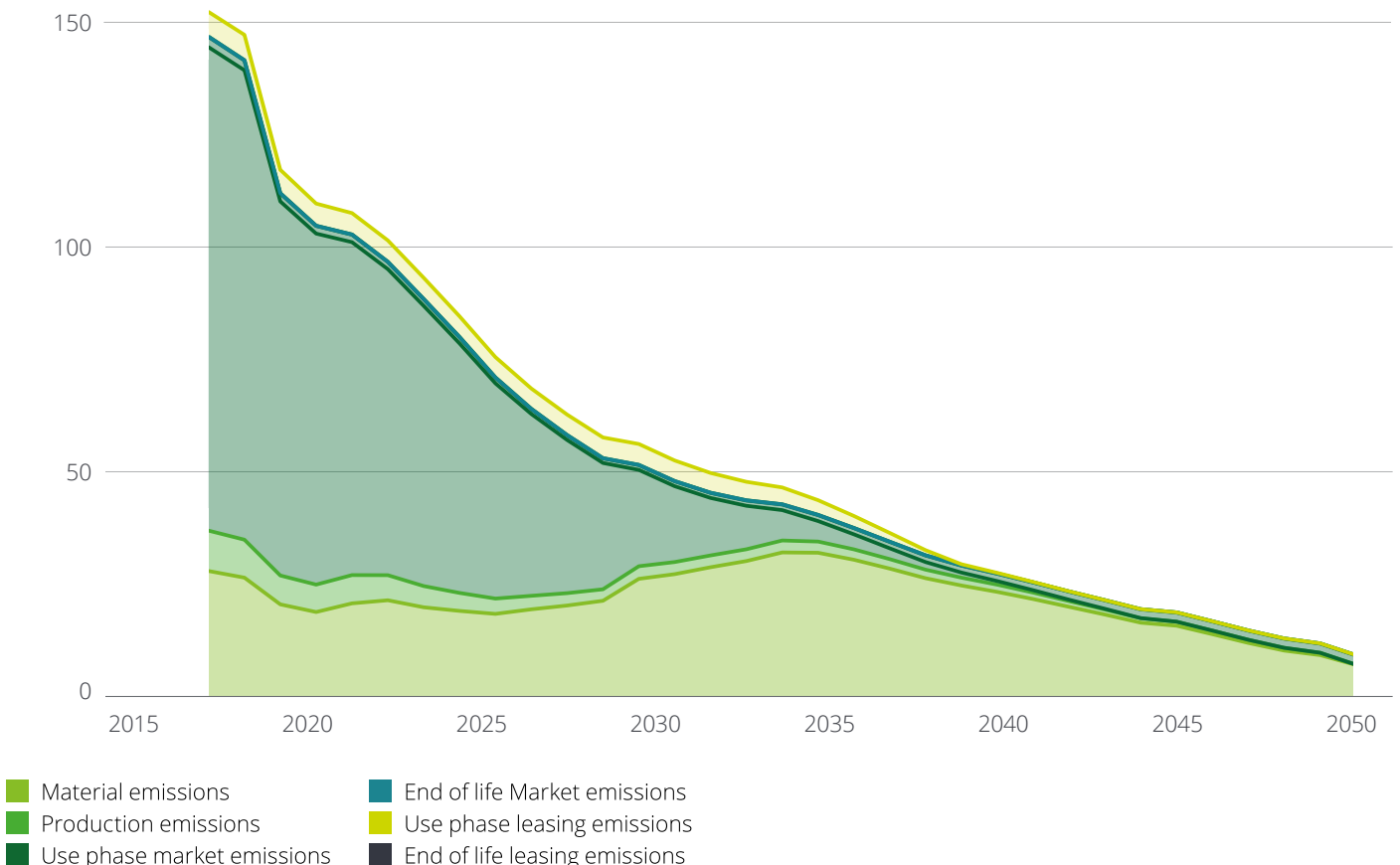
warming to well-below 2°C, despite the target being an absolute reduction target and the OEM's growing market share. In 2030, the OEM would have already reduced emissions by 62% compared to base year 2018.

Even when applying all these decarbonization levers, there will likely be emissions that cannot be abated. The net-zero standard requires that by 2050, these residual emissions represent less than 10% of base year emissions and are neutralized by removing carbon from the atmosphere and permanently storing it. Residual emission levels were only reached by the frontrunners in the model.

**Fig. 11 – Yearly carbon emissions in the aggressive approach**

#### Reported carbon emissions by year

in million tonnes CO<sub>2</sub>e

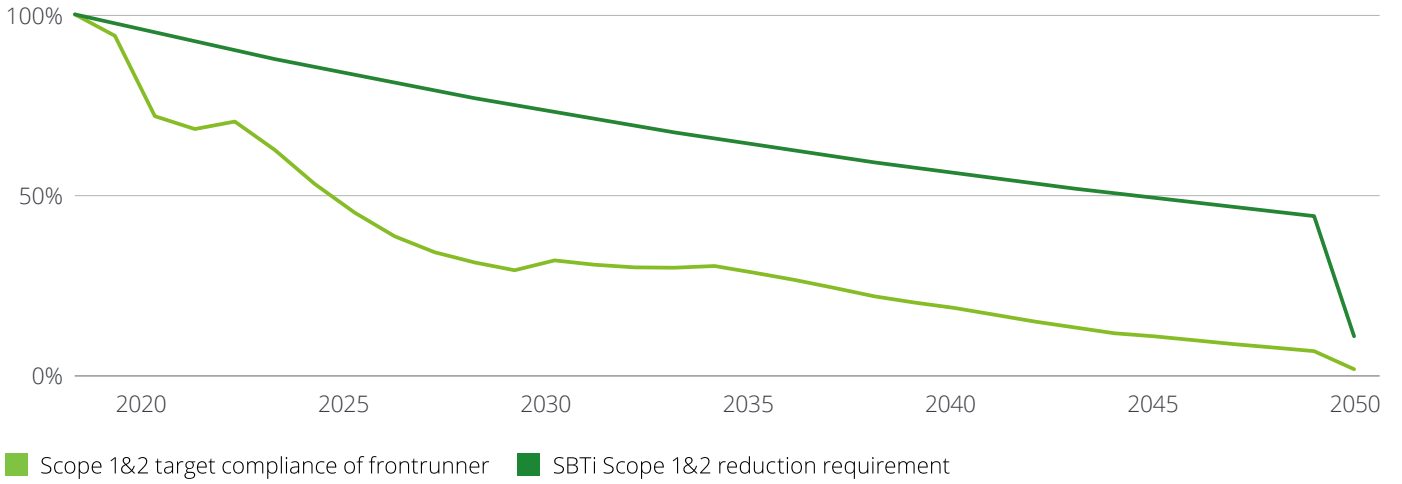




**Fig. 12 - SBTi net-zero target compliance in the aggressive approach**

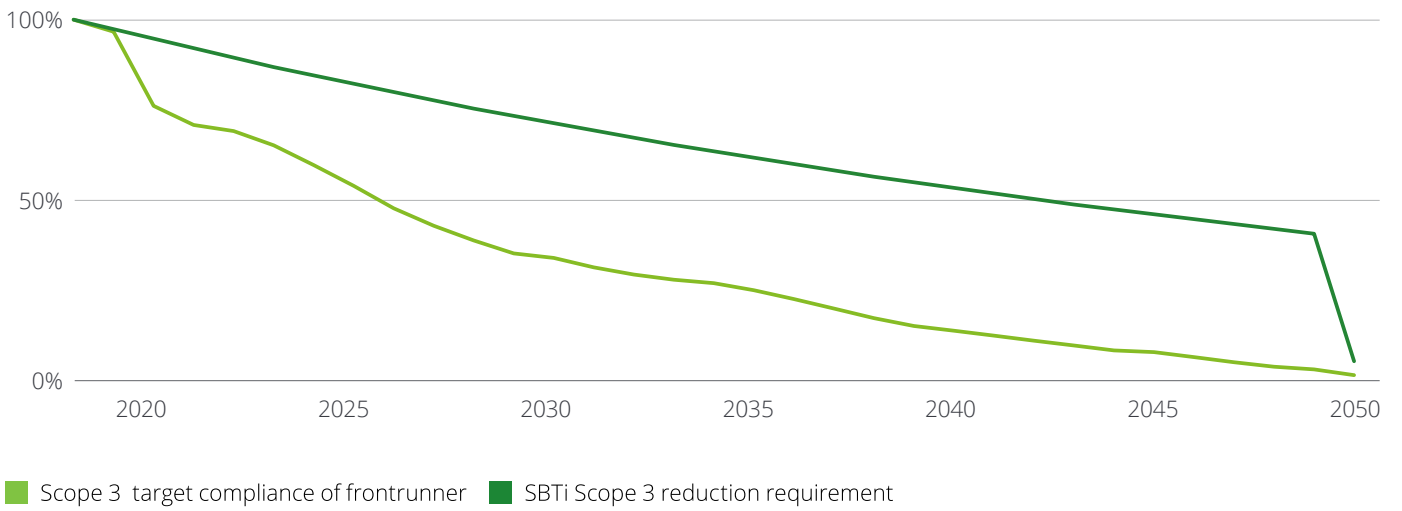
**Scope 1&2 target compliance**

Percentual remaining emissions compared to base year



**Scope 3 target compliance**

Percentual remaining emissions compared to base year





### Impact on vehicle production

As of today, direct sales represent the OEM's most important revenue stream, therefore profitability should be sought especially within this area. On a global level, it is expected that direct vehicle sales will diminish by up to 30% by 2030 compared to 2022, mainly due to changing customer demands. Similarly, in the managing expectations pathway, the frontrunner at first cannot compensate declining ICE sales with enough BEV sales, but after 2030 the OEM's BEV portfolio catches up and a recovery is possible, reaching prior sales levels and even doubling sales by 2050 (compared to 2022). Under more favorable conditions in a progressive world, this can be realized even earlier (bold bet pathway of the frontrunner in progressive scenario). China provides a partial reason for the recovery of direct sales revenue, as their total vehicle fleet will likely increase in time and therefore counteract revenue losses on a global level. Future viability depends on the OEM's competitive advantage and, in effect, its ability to secure and extend market share.



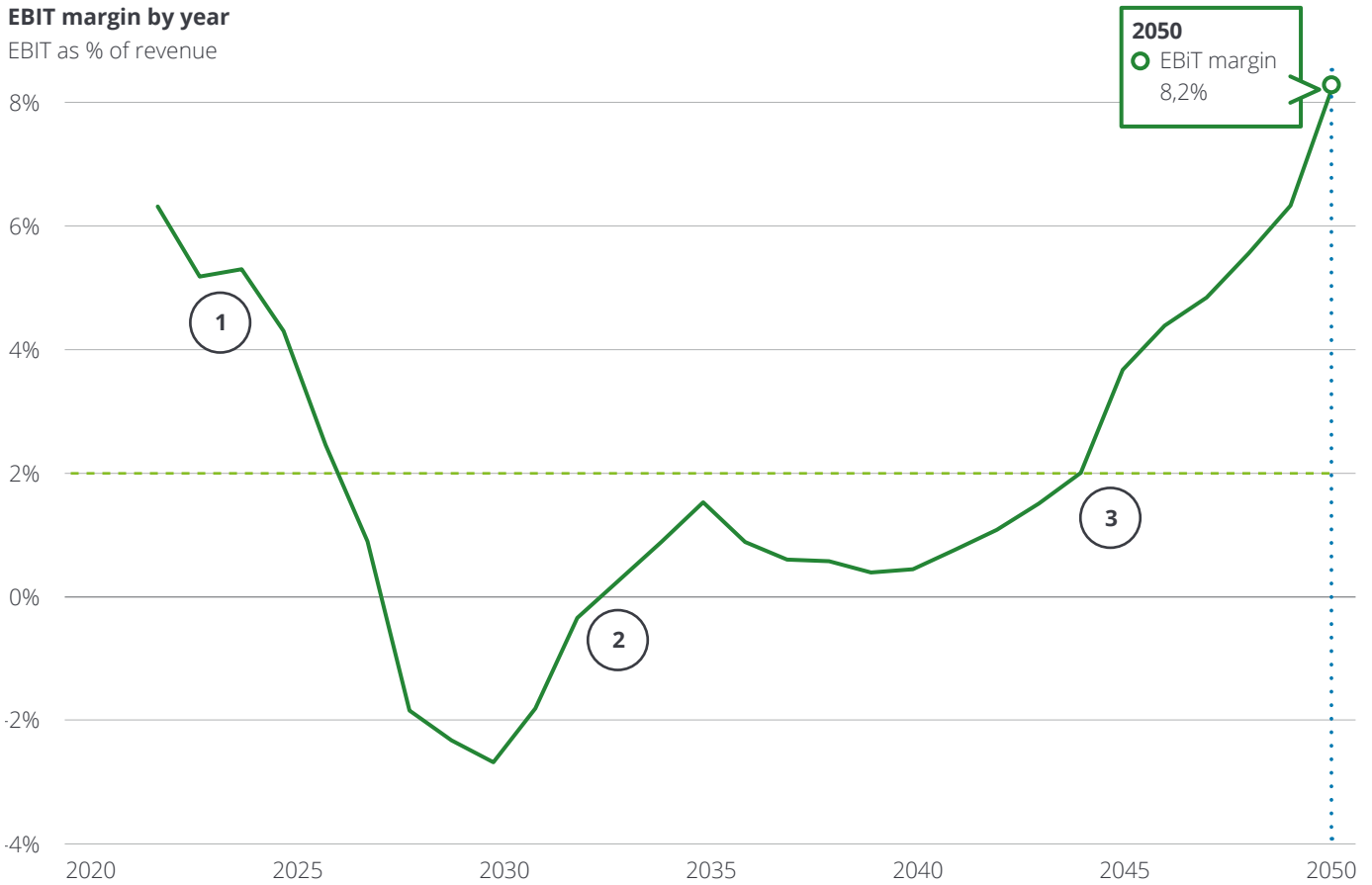
### Impact on P&L

**To achieve a net-zero future, early and massive investments by OEMs are necessary in all areas of the company – which may cause a significant negative effect on the income statement and balance sheet in a short- to mid-term perspective.**

Profitability is at risk during the transition to net-zero. Our modeling shows that being a frontrunner drives costs up. It means purchasing green materials and securing green electricity even though these are not broadly available in the market and come with some material price premiums which OEMs need to pay in the beginning. Moreover, shifting the product portfolio away from the profitable ICE business requires counterbalancing the revenue with new products or services. New sources of revenue that are strongly linked to BEVs should be actively developed (e.g., skimming off trading margins, software revenues and data monetization, mobility as a service solution, fleet operations instead of one-off sales). OEMs need to quickly make the BEV product range more economical (battery value chain, reduction in the number of variants, platform synergies, etc.). In effect, OEMs might face up to five years negative EBIT if not properly equipped to master the twofold mission of decarbonization and profit generation.

EBIT margin will likely suffer with the green transformation ((see Figure 13 (1)) but recover in time above initial level accompanied by increased market share (((see Figure 13 (2 and 3)).

**Fig. 13 - EBIT development for a frontrunner (aggressive approach)**



But how can the OEM counteract these negative EBIT developments following an aggressive approach as a frontrunner? With smart strategic choices, the frontrunner can limit the impact of the costly transition phase in the coming years. An early shift to BEV and the conversion of old ICE plants combined with the avoidance of long parallel runtimes for BEV and ICE production could help reduce complexity costs.

While increasing leasing business provides a good base, it likely won't be enough to compensate the ICE profitability drop due to the shift to BEV and sinking vehicle demand. New revenue pools as software-based vehicles, data monetization and other digital assets need to be built.

Moreover, further efficiency increases in production and the reduction of material input and vehicle weight as well as a lean portfolio in general with less variants can lower costs. With COGS—especially materials with their increasing prices and green surcharges—it is essential to work closely with suppliers and service providers. Long-term collaboration and joint investments in green measures can lead to certainty for both suppliers and customers paired with better purchase conditions. Industry-wide collaborations and standardization of components, e.g., for batteries, and data transparency by using smart labels and product passports, can help simplify downstream processes and reduce costs for the reprocessing of materials.

In addition, return services for customers combined with close cooperation with recyclers can further safeguard materials availability and lead to more cost-effective raw materials processing. Besides realizing cost-savings, profitability needs to be sought within old and new revenue streams. As the share of leased vehicles will likely have a significant impact on the revenue streams and will likely increase by up to 90%, it could represent a major revenue source for OEMs in the next 10 to 15 years. The frontrunner could drive its profitability with early offerings and the expansion of flexible mobility services (see Figure 14).



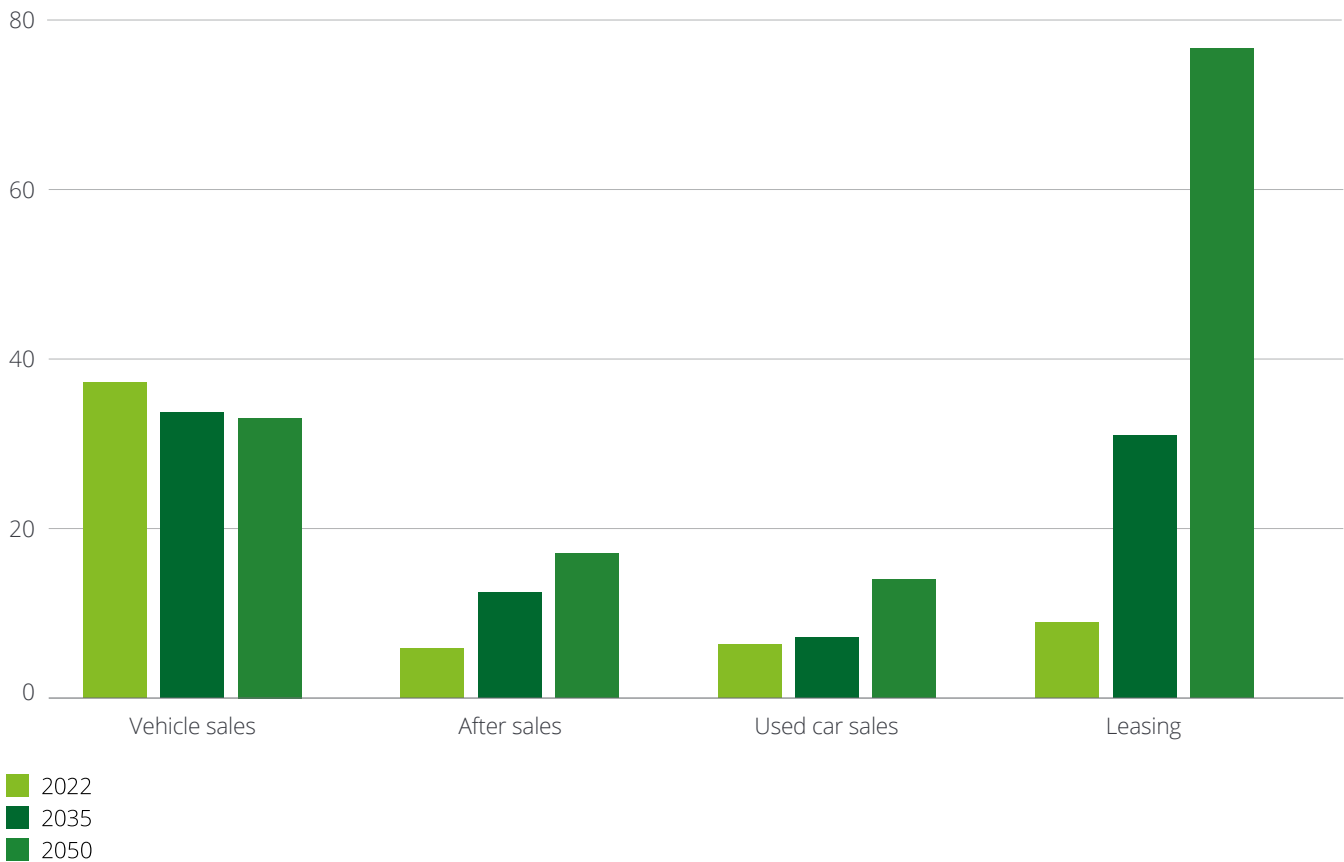
### Impact on OEM workforce

Some of the levers, such as the shift from ICE to BEV, will likely have a high impact on the OEM workforce. Since the workforce is assumed to develop in line with vehicle sales, the chosen behavioral path has a heavy impact on the OEM workforce. In the aggressive approach, the total number of OEM employees increases from about 120,000 in 2022 to about 161,000 employees in 2050.

**Fig. 14 – Development of a frontrunner’s revenue sources (aggressive approach)**

#### Development of a frontrunner’s revenue sources

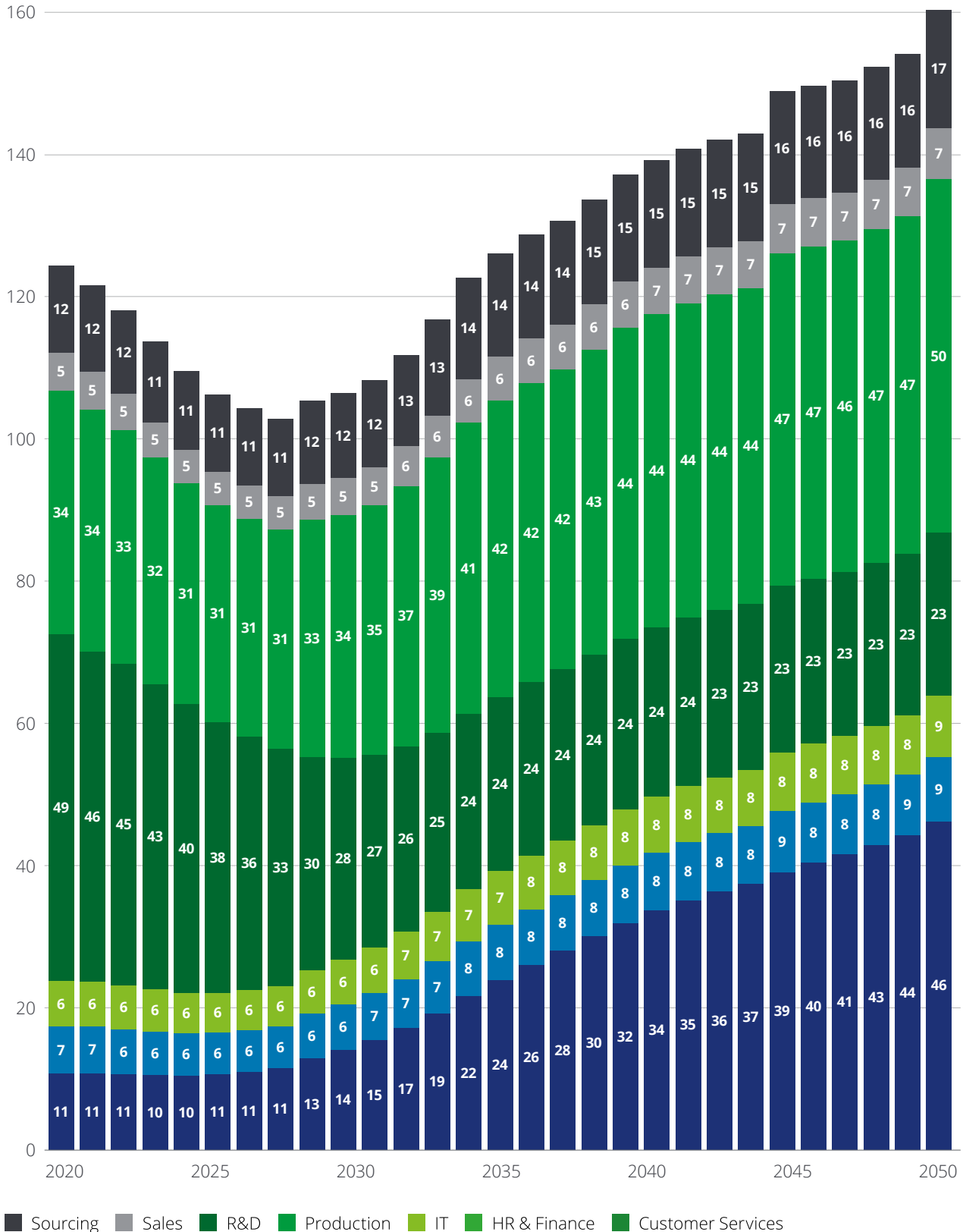
billion USD



**Fig. 15 - OEM workforce forecast frontrunner (aggressive approach)**

**Total workforce by year**

Number of employees in thousand



**Aggressive approach versus bold bet**

With the bold bet pathway, in a world that is moving towards sustainability, the OEM is supported in its decarbonization journey. Here, the OEM also manages to reduce its emissions to 6.2% residual emissions by 2050. Regarding average emissions per vehicle produced, a favorable environment helps the OEM to further lower lifetime

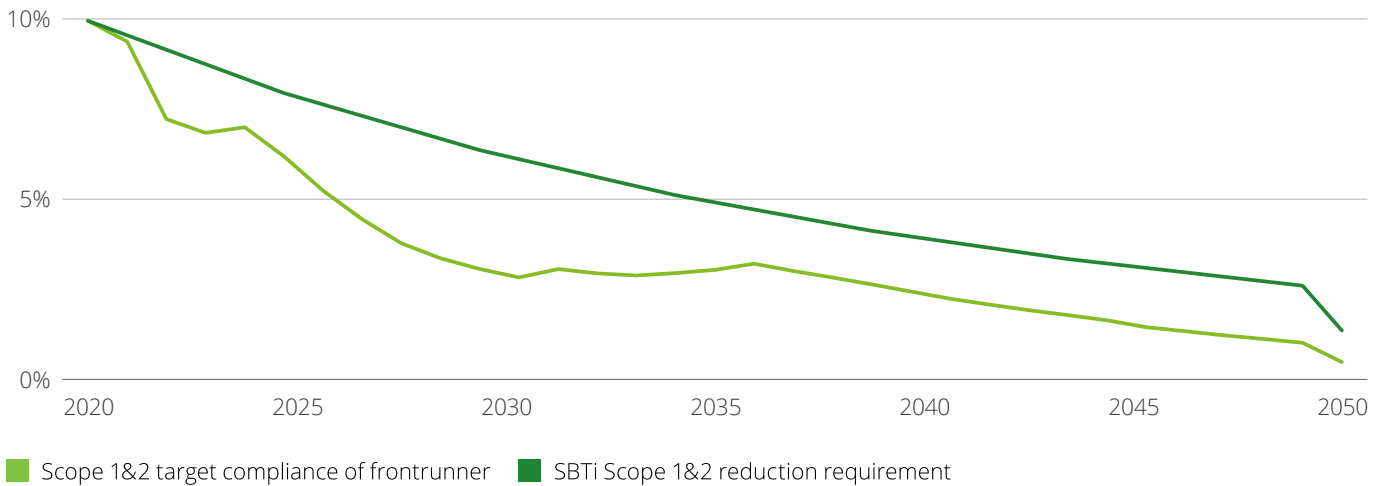
emissions of BEVs (e.g., in 2035 9.8 tCO<sub>2</sub>e/BEV in Germany in the bold bet pathway compared to 12.9 tCO<sub>2</sub>e/BEV in the aggressive), which allows the OEM to sell more vehicles without compromising decarbonization targets. Cumulative emissions from 2018 to 2050 are reduced by 9.0% compared to the baseline progressive case.

In the progressive scenario, the ambition of the OEM is to limit global warming to 1.5°C. As a frontrunner, the OEM still manages to follow this more ambitious decarbonization path:

**Fig. 16 - OEM target compliance in the bold bet pathway**

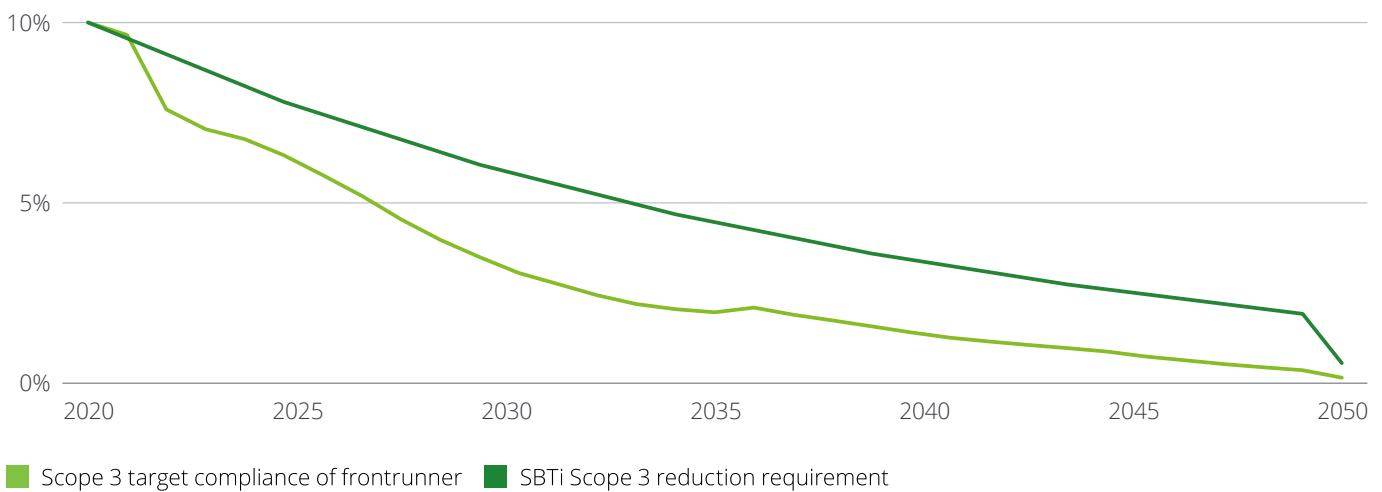
**Scope 1&2 target compliance**

Percentual remaining emissions compared to base year



**Scope 3 target compliance**

Percentual remaining emissions compared to base year







Vehicle numbers in the bold bet pathway show an even higher and accelerated sale of BEVs than in the aggressive approach, since the OEMs drive train shift is supported by regulatory and market developments. Similarly, the OEM increases its workforce even more to 167,000 employees in 2050. The main difference between both pathways lies in the lower EBIT margin in the bold bet. In the aggressive approach, the EBIT margin will likely drop up to -4% in 2030, while the bold bet will likely fall to -5% due to stricter climate regulations and higher carbon pricing, e.g., on conventional materials and energy sources, which are still used in the coming years.

In both scenarios, the frontrunner achieves net-zero and can become profitable again through market share gains after periods of losses. The main difference lies in the lower total cumulative emissions of the bold bet (1.34 gigatons CO<sub>2</sub>e), compared to the aggressive approach (1.45 gigatons CO<sub>2</sub>e), and its higher EBIT margin, both likely due to a favorable market environment that lowers the costs of decarbonization for the OEM.

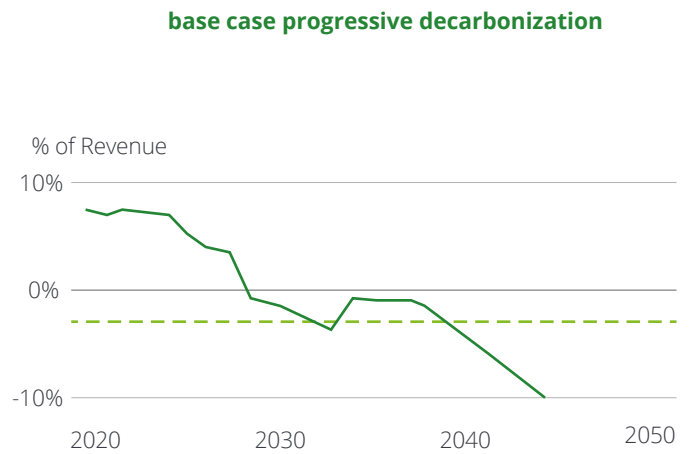
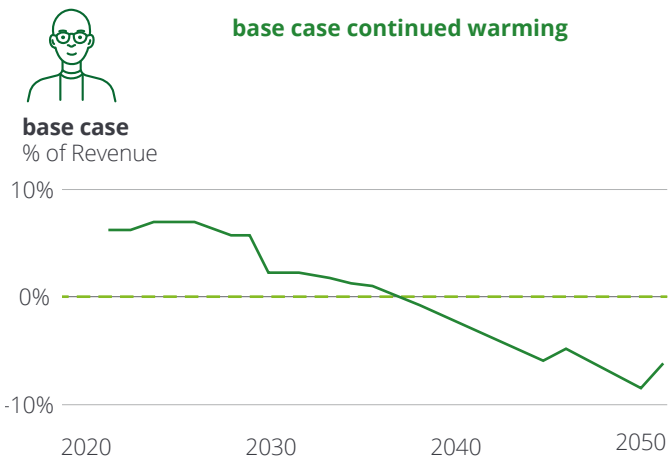
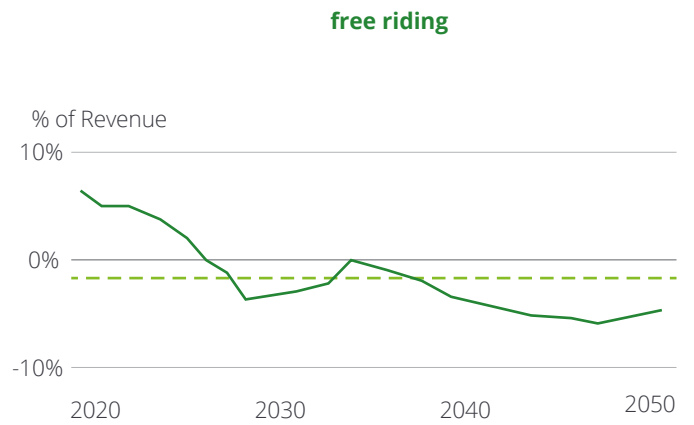
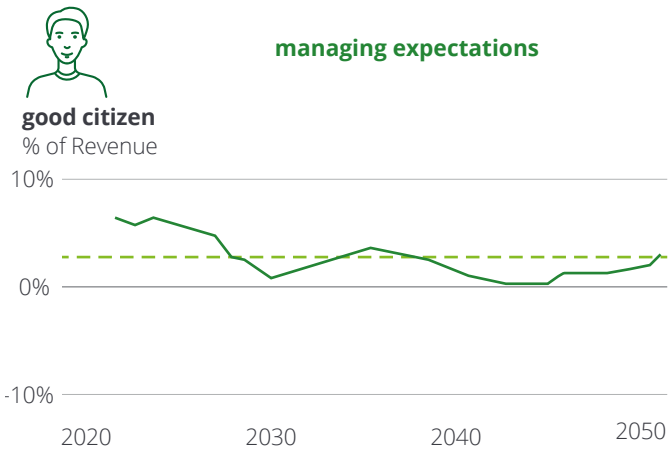
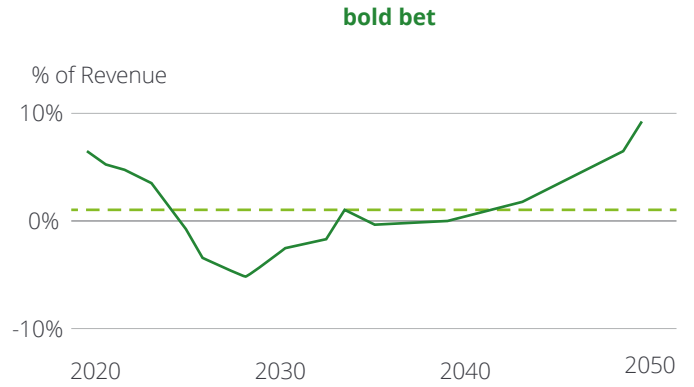
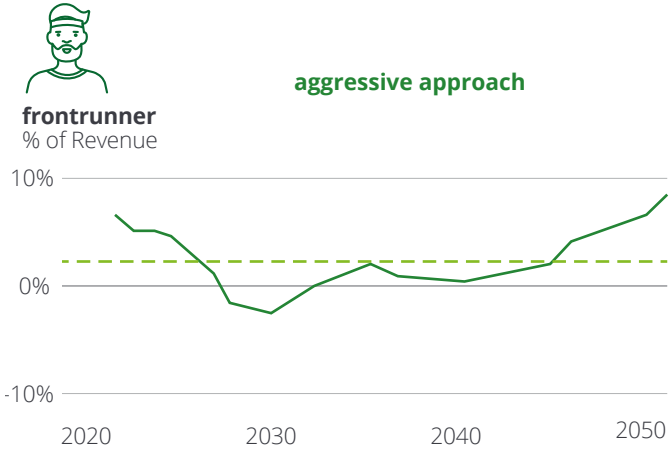
**Summary of results**

Table 1 provides a summary of the decarbonization pathways and their impacts.

**Tab. 1 – Summary of impacts of four decarbonizations pathways**

	 <b>Managing expectations</b>	 <b>Free riding</b>	 <b>Aggressive approach</b>	 <b>Bold bet</b>
Residual emissions (2050)	<b>14.5%</b>	<b>13.5%</b>	<b>6.4%</b>	<b>6.2%</b>
Total carbon emissions (2018–2050)	<b>2.14 gigatons CO<sub>2</sub>e</b>	<b>1.88 gigatons CO<sub>2</sub>e</b>	<b>1.73 gigatons CO<sub>2</sub>e</b>	<b>1.62 gigatons CO<sub>2</sub>e</b>
Total vehicles produced (2022–2050)	<b>57.0 million</b>	<b>62.3 million</b>	<b>80.2 million</b>	<b>90.4 million</b>
Market shares (2050)	<b>5%</b>	<b>5%</b>	<b>10%</b>	<b>10%</b>
OEM Workforce (compared to base year 2022)	<b>-15%</b>	<b>-12%</b>	<b>+29%</b>	<b>+35%</b>
EBIT (2050)	<b>3%</b>	<b>-5%</b>	<b>8%</b>	<b>9%</b>
Cumulated EBIT (2022 – 2050)	<b>&lt; 0 bn\$</b>	<b>~41 bn\$</b>	<b>~40 bn\$</b>	<b>61 bn\$</b>

**Fig. 17 - EBIT development in the six pathways**



**status quo**

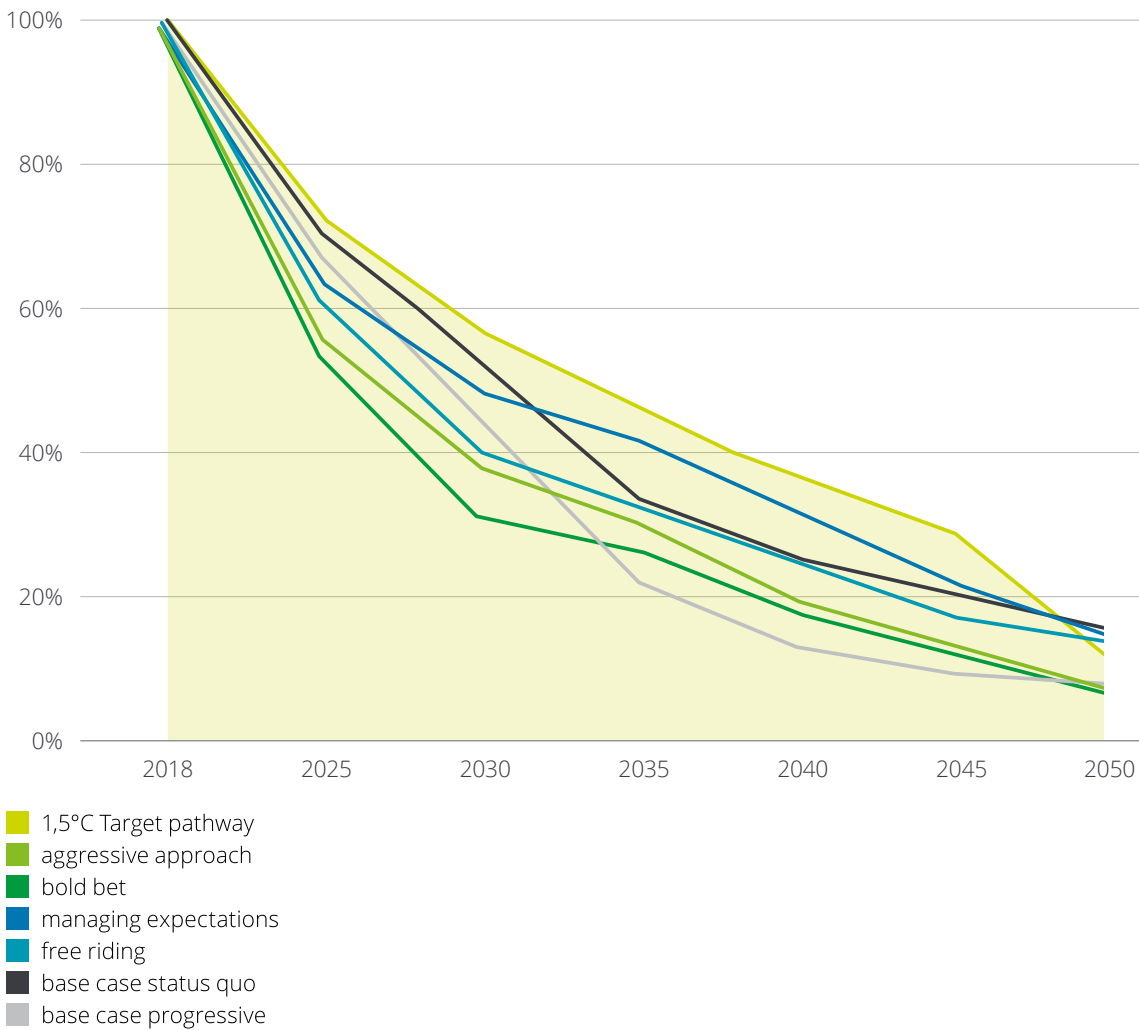
**progressive**



**Fig. 18 - Comparison of potential decarbonization pathways and SBTi net-zero cross-sector 1.5°C target pathway**

**Comparison of potential decarbonization pathways**

Remaining CO<sub>2</sub>e emissions in % compared to base year 2018



**Note:** The base case decarbonization pathways also show a significant reduction in emissions. However, this is due to a strong decline in vehicle sales and an associated loss of market shares and due to deliberate decarbonization efforts.

# 06. Risks & consequences of insufficient decarbonization

What is the risk of being undecided?

## You will likely miss out on BEV market share

A decarbonization strategy that is too slow will likely lead to a loss of (BEV) market share. Rapid decarbonization is therefore the method of choice to help maintain a strong position in the market as well as to keep pace with new Chinese/Asian BEV providers.

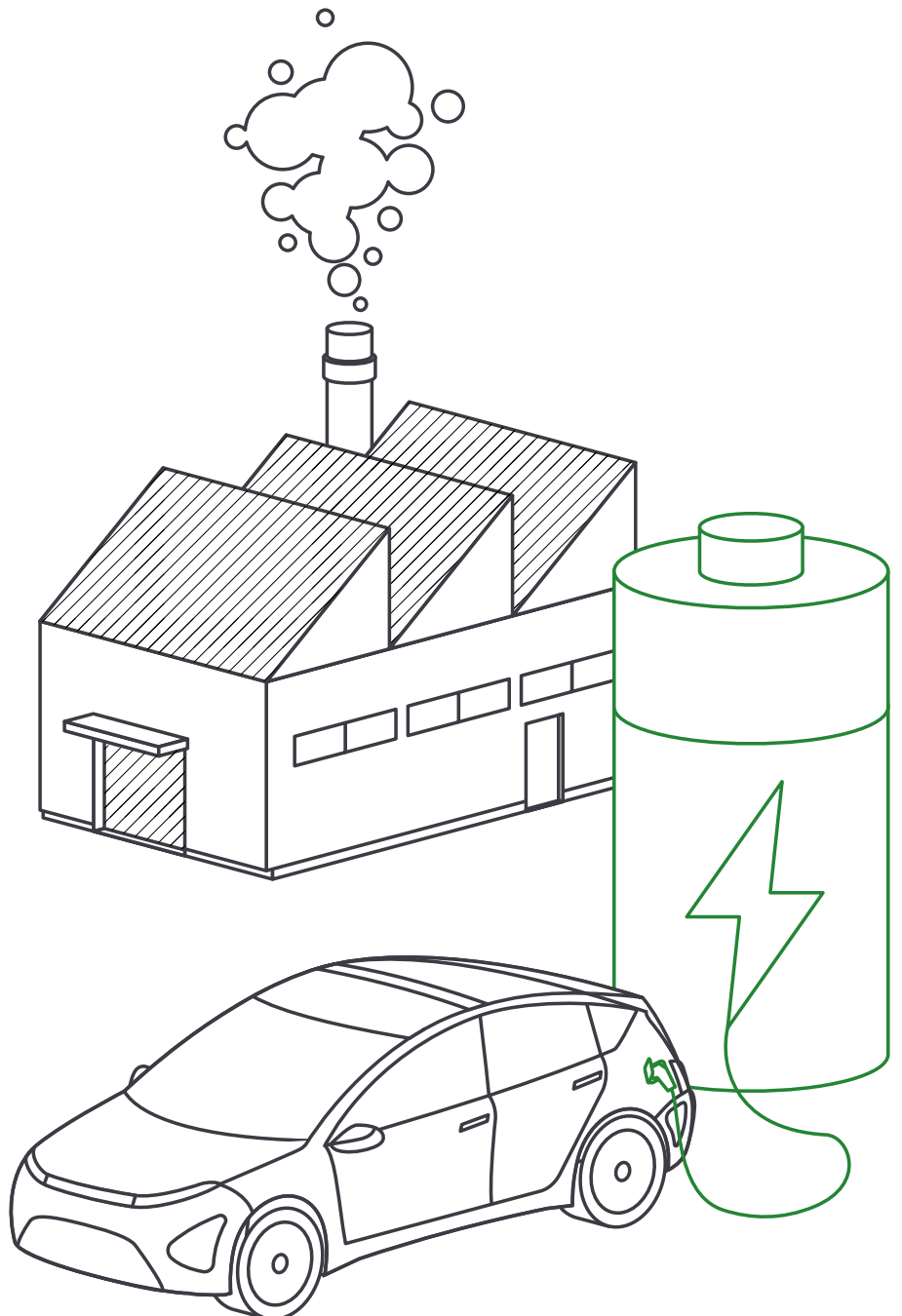
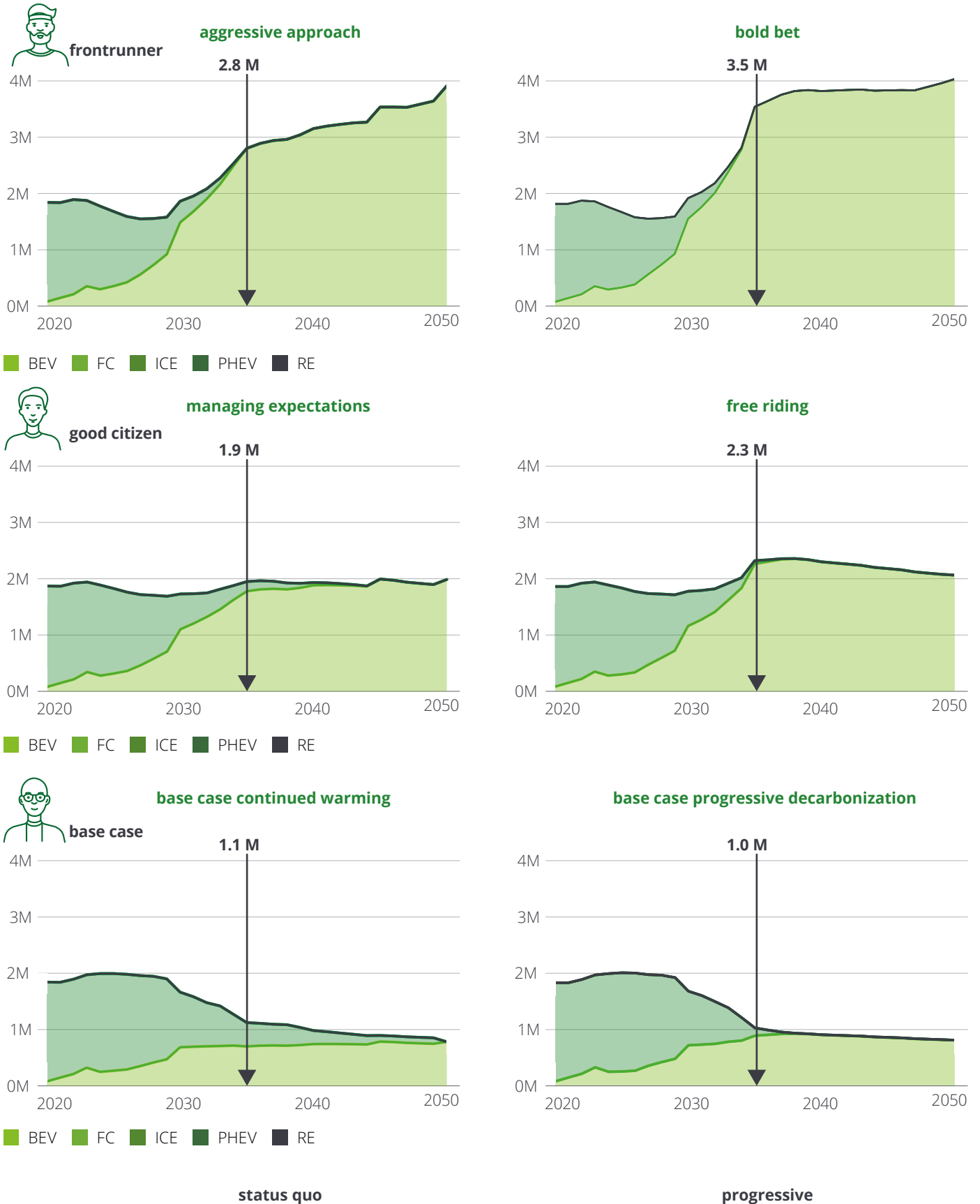





Fig. 19 - Development of ICE and BEV production in the six pathways



Future automotive production will likely be dominated by electric vehicles in the long-term. Therefore, for OEMs to maintain, or even increase, future competitiveness and profitability, it may be crucial to secure EV market share at an early stage. A series of factors will likely influence the distribution of future EV market share among companies. These factors can be actively shaped by the OEM but need to be addressed in a timely manner.

**Tab. 2 – Summary of factors enabling market share growth**

<b>Market Shares Uplift enabled by ...</b>	<b>1</b>	<b>2</b>	<b>3</b>	<b>4</b>
<b>Behaviour of different OEMs</b>	<b>Current Profitability &amp; Investment to ramp-up BEV capacity</b>	<b>Supplier Network &amp; Readiness to deliver BEV components</b>	<b>Customers Brand Loyalty during transition of product segments</b>	<b>Merger Endgames Global market consolidation</b>
 <b>frontrunner</b>	Lead with targeted investments at an early stage. Fast transition to BEV in order to secure market shares. Maintain low complexity by ramping down ICE production.	Analyze their established supplier base regarding the suppliers positioning to deliver BEV components at scale securing the ramp-up. Extend the supplier base as needed.	Actively involve their customers in the transition towards BEV in order to ensure customer brand loyalty is maintained during the shift of the product portfolio across segments	Drive market consolidation to secure market shares in EV Market by absorbing equal competitors across the regions.
 <b>good citizen</b>	Make selected investments in BEV awaiting general market developments. Plan for an economic ramp-down of ICEs despite the high complexity cost of managing both types.	Rely on their established supplier base to deliver BEV components at scale when required by the market.	Serves the ICE and BEV market depending of the customer willingness to pay. Awaiting customers demand for sustainable products.	Assumes participants in the market remain stable on the long-run.  Does not consider the merger of the equals and does not emphasize new players.
 <b>base case</b>	Overall profitability declines with the ICE Market Ramp-down. Does not make targeted investments to ramp-up BEV capacity, losing market share by being late to the game.	Solely relies on traditional supplier networks to deliver ICE and BEV components.	Focusses on serving the ICE market with limited ambition to extend the customer base.	High risk to be displaced out of the market with the regulation decisions to shift towards BEV.
<b>Endurance strategy &amp; merger of equals</b>				

Capturing BEV market share in the early phases of decarbonization depends, among other factors, on the supplier network and their ability to support the steep ramp-up curve to introducing new products. Here, Chinese BEV manufacturers are better positioned due to their proximity to essential raw materials required for battery cell production being able to secure scarce materials at market tipping points. This represents a clear competitive advantage for Chinese OEMs.

Shaping market determinants early provides several advantages to OEMs, such as supply assurance, customer loyalty, and faster positioning in the EV market. In contrast, a slow transformation poses significant risks to future competitiveness. In fact, today's market leaders may lose share if they lack leadership during market tipping points. This was already experienced in the past by other industries that were subject to technological disruptions.

### Displacement in the technology industry

A review of several examples shows that in a relatively short time frame of five to seven years can a leading company lose substantial market shares, or even be displaced out of the market. For example, since mobile phones quickly became mainstream in the early Nineties, Nokia dominated the market for two decades. Its leadership started to decline with the year 2008<sup>29</sup> – six years later, in Q2 2014, the market share dropped for the first time under 10%<sup>30</sup> and thereafter became quickly insignificant. Key reason for this was its inability to maintain its competitive advantage as other market participants and new entries managed to innovate the product. Nokia's operating system did not keep up with the capabilities of competitors' operating systems, especially following the market entry of Apple iOS in 2007 and Google's android in 2008. Moreover, Nokia's management decisions were based on the expectation that consumers prefer keypad layouts, not expecting high adoption rates for mobile phones with touch screens.

Another, related example is the camera market, which showcases the impact of customer brand loyalty and buying behavior. Initially, digitalization was the key driver for substantial market growth (between 2000 and 2010 global sales increased from 42 million to 121 million units<sup>31</sup>) as it enabled the switch from traditional film to digital cameras, making images instantly accessible to their users. However, by 2021, sales plummeted to 3 million units as the market segments of entry-level and medium range cameras were by then overtaken by mobile phones. In fact, with advances in lenses and computational power, the quality of cameras increased substantially and became one of the stand-out features of mobile phones.

To summarize, speed comes with a cost risk- but no speed can be even riskier. Fast ICE ramp-down paired with experience and brand-driven gains of BEV share while managing a short (even painful) transition to BEV will likely lead to an overall increase in sold vehicles by 2050. Only the fast behavior of the Frontrunner leads to an increase in BEV market share from 5% to 10% in 2050, while a good citizen maintains its BEV market share and the base case loses BEV market share.

**Fig. 20 – Resulting ICE and BEV market share in the three cases**



OEMs market share on overall ICE market     
  OEMs market share on overall BEV market  
 OEMs ICE sales range (depending on scenario)     
  OEMs BEV sales range (depending on scenario)

### Risking regulatory penalties

Due to the increase in ICE sales after the German subsidies are phased out, the OEM might face a fine for missing the EU fleet targets for tank-to-wheel use-phase emissions of new vehicles sold as currently defined. If the average fleet emissions exceed the OEM's specific emission target, it must pay an excess emissions premium of ~\$100 per g/km of target exceedance for each of its vehicles newly registered in the EU, Norway, Iceland and Liechtenstein that year.<sup>32</sup> For example, with the OEM's vehicles registered in the EU in 2025 in the free riding pathway,<sup>33</sup> this would lead to a fine of ~\$65 million per g/km target exceedance. Missing the target by 5 grams would cost the OEM ~\$313 million in fines. Therefore, the OEM should make sure, not only for financial but also reputational reasons, that it meets the yearly emissions target by closely monitoring vehicle sales and engaging in pooling with other car brands of their own corporate group or independent manufacturers. Through pooling, manufacturers can join forces to meet their emissions targets but must follow the rules of competition law. A pool is viewed as a single manufacturer for the purposes of the CO<sub>2</sub> emissions regulation, allowing manufacturers with low fleet emissions to offset the high fleet emissions of other manufacturers.<sup>34</sup>

Moreover, there is a risk that regulators might apply further regulations beyond new vehicles sold impacting all vehicles currently in operations. Considering an average lifetime of about 16 years, the fine for target exceedance can become enormous.

### Impact of sustainable business practices (including decarbonization) on financing

As financial capital undoubtedly becomes a driver of sustainable transformation, investors' credit decisions and risk considerations will likely rely more and more on sustainability criteria such as ESG data, ESG ratings, or EU taxonomy performance. Already today, capital markets penalize companies that

have not implemented sustainable business practices and have not started to decarbonize their businesses as the assumed default credit risk is greater.<sup>35</sup> As a result, there is likely not another path for OEMs other than becoming sustainable.

OEMs commonly depend on debt capital to finance operations, investments and, particularly, also the growing leasing fleet. As investors increasingly focus on ESG criteria, frontrunners typically have better options for refinancing their business. It enables them to access funding for investments in CO<sub>2</sub>-neutral technologies and services, which may be realized at a borrowing cost advantage. Notably, it has been found that as of the year 2019, green corporate bonds have, on average, an eight basis points lower yield spread at issuance compared to conventional ones (also known as "greenium").<sup>36</sup>

As a result, with increasingly strict rules in terms of ESG criteria of institutional and private investors, OEMs delaying their transition to a green business model may find it more and more difficult to access capital. Similarly, smaller companies, without sufficient resources to provide transparency on their sustainability performance, are often penalized by capital markets. Setting ambitious sustainability goals and providing carbon disclosure is no longer optional.

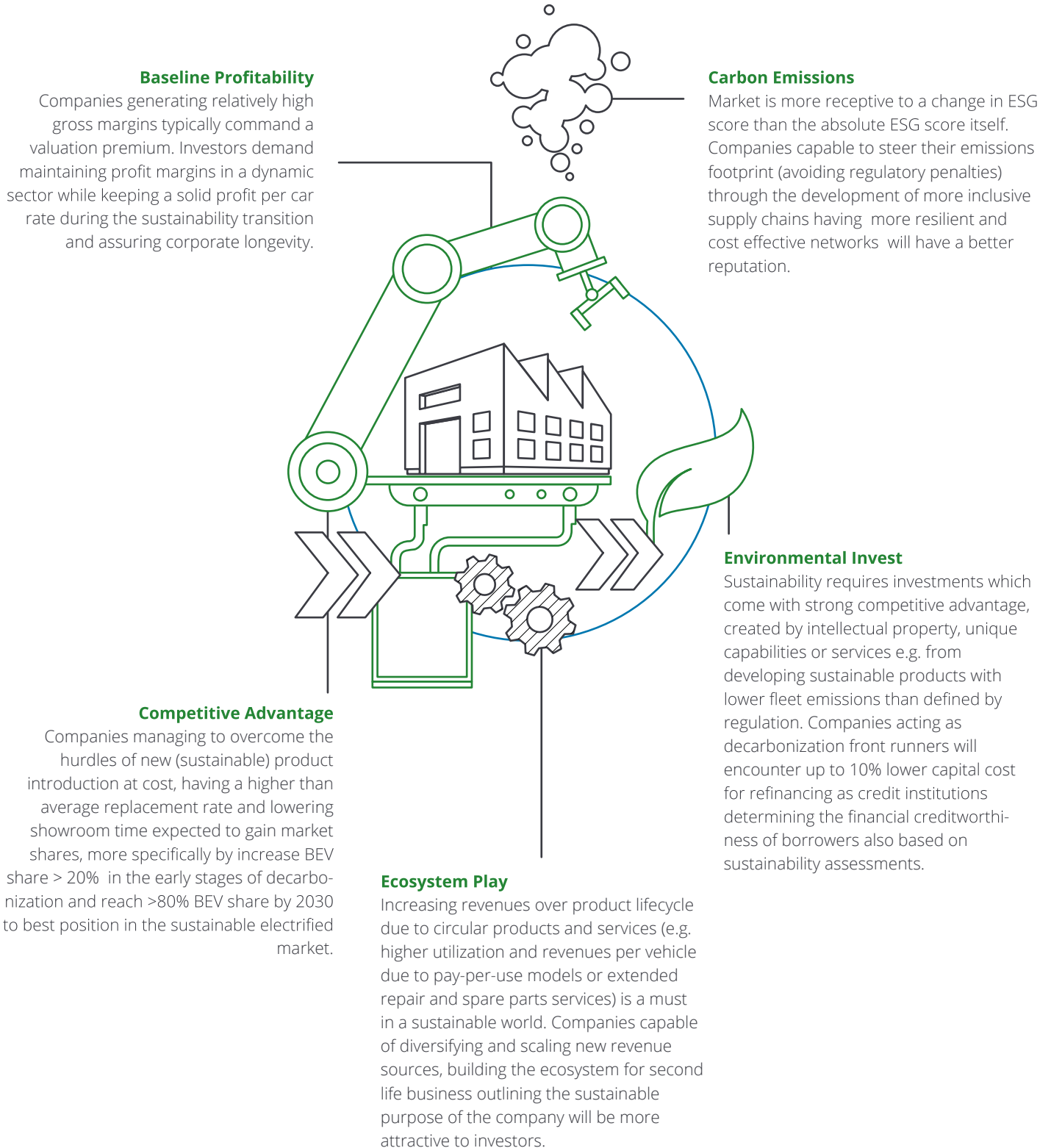
While the baseline portfolio is key in the beginning of the transformation, it is also important to build partnerships within the ecosystem and extend the business model towards more sustainable income sources. As pressure mounts from investors, boards, and executives to track and report payoffs, governance is critical. Companies placing sustainability at the center of their performance measurement system - on the same level as economic performance metrics - can increase the speed of transformation. During each phase, different factors will likely have a greater impact on valuation than others (see Figure 21).

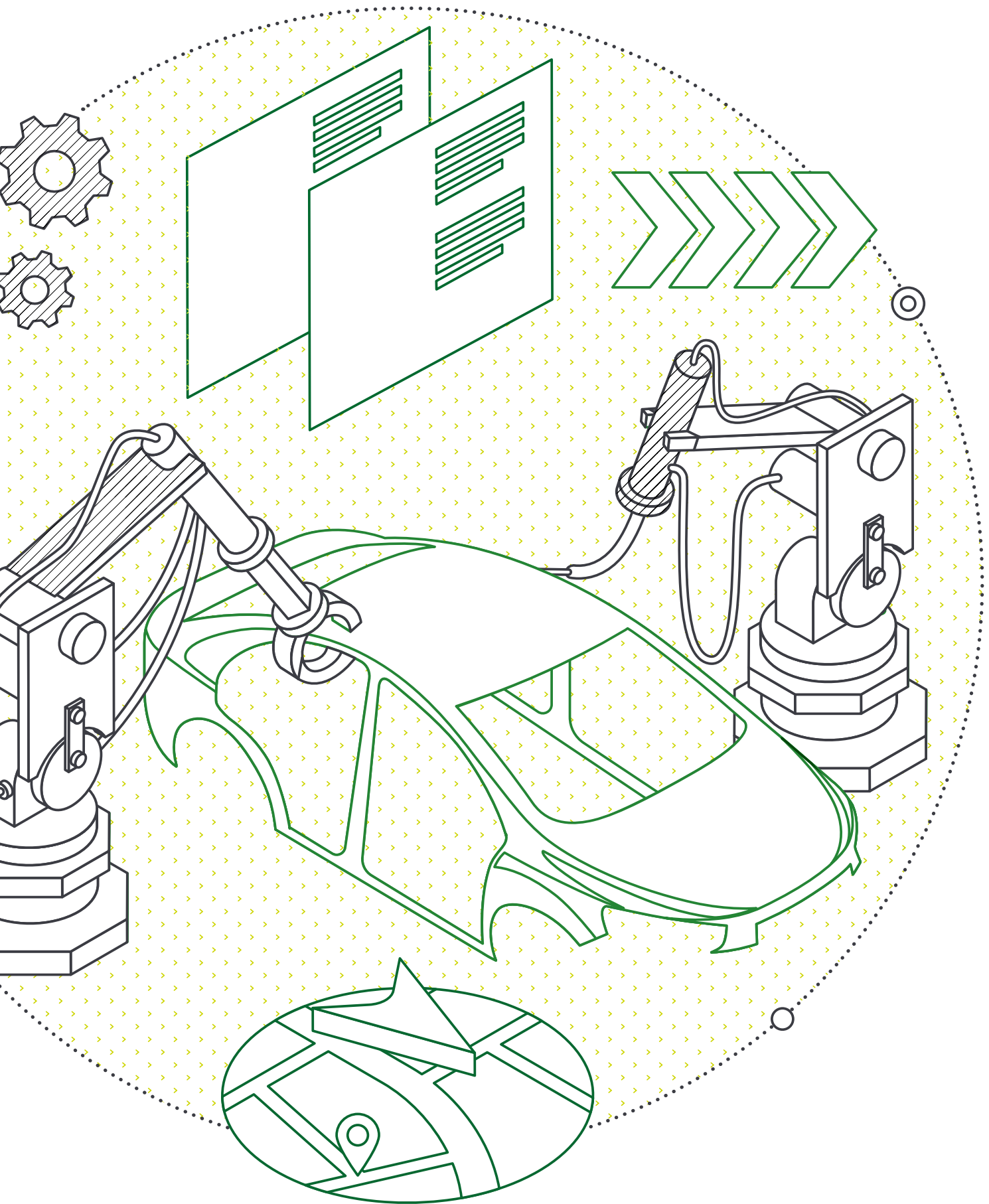
“Frontrunners have the opportunity to partly offset the initially lower profitability of electric vehicles compared to ICEs with cheaper refinancing costs. The Deloitte team has found companies managing the environmental and the social pillar scores well, with up to a 10% decrease in cost of debt.”<sup>37</sup>

Andreas Emmert, Partner



**Fig. 21 – Company valuation factors**





# 07. Strategic moves for a successful net-zero transition

What should be done to help ensure the viability of the automotive sector?

The automotive sector is a cornerstone of mobility systems worldwide as well as a key pillar of the global economy. But it is also a major contributor to climate change. It is therefore essential that OEMs work to become carbon neutral, applying decarbonization levers and taking a frontrunner position. But with smart strategic choices, OEMs can overcome the costly transition

phase in the coming years. What can be done to help mitigate these negative financial impacts and what strategies are needed for a successful transition to net-zero? The following strategic moves can help:



### 1. Build a future-proof strategy and actively involve your workforce

Integrate your decarbonization ambitions into a future-proof strategy and actively involve your workforce to help ensure a successful transition and drive new targets. Get started on transitioning your workforce towards BEV and get employee buy-in for decarbonization and your climate strategy. The transition will likely be challenging for OEMs and suppliers, especially because of a complete change of production processes and the need to develop new technologies. As there are differences in the skills, tasks, and workers required to build electric cars, compared to vehicles with internal combustion engines, there are important workforce and skilling considerations to be factored into policy and workforce planning.<sup>38</sup>



### 2. Invest actively in the decarbonization of the value chain

Investing in low-carbon materials, production, and usage models is needed to help ensure green material and green energy availability, accelerated future profitability, and prevention of regulatory penalties. Long-term collaboration and joint investments in green measures can lead to securities for both suppliers and customers paired with better purchase conditions. Going forward, levers should combine BEV products with green electricity as well as with circular business models and materials. To do this, OEMs should massively invest in circular business models to help secure access to these materials.

Moreover, the tipping point between green and grey electricity costs is likely to be reached after 2037. At that time, green electricity costs may be the same as the average cost of electricity in the market, as the carbon price raises the market electricity price after tax.

The decarbonization challenge is to identify the right levers and the appropriate timeframe to implement them: too early and the OEM might suffer disproportionate costs that were not necessary for decarbonization, too late and the OEM risks getting above 1.5°C and missing the net-zero target.



### 3. Get up to speed with decarbonization to shorten the transition

As future profitability heavily depends on the ability to capture market share of electric vehicles in the early on, speeding up the transition to the e-mobility market may become a strategic imperative.

Long transition periods are costly and targeted investments at an early stage can enable OEMs to achieve technology leadership on the one hand and exploit cost synergies on the other. By speeding up the transition to EVs, the payback period of investments can be achieved earlier, while at the same time additional EV market share can be gained. A fast transition with an early shift to BEV and the conversion of old ICE plants combined with the avoidance of long parallel runtimes for BEV and ICE production could help to reduce complexity costs.

When shifting the product portfolio from ICE to BEV, brand loyalty should be maintained as product portfolio transitions are risky if customers are not actively involved early on. Today, a typical automotive design cycle takes approximately 24 to 36 months, which is much faster than the 60-month lifecycle from five years ago. Due to the long product lifecycles of the automotive industry, investments can have a delayed effect—which is why they should be made now. OEMs already investing and tackling CO<sub>2</sub> reduction will likely emerge as winners by transitioning away from the finite ICE business and by increasing market share in the BEV market by about 50% in 2030 compared to 2020.



#### 4. Optimize your supplier network to help secure BEV supply and implement cost and energy efficiency programs

Industry-wide collaboration and standardization of BEV components (e.g., batteries) and data exchanges could also simplify processes and reduce costs. In terms of COGS and especially the material part with its increasing prices and green surcharges, it can be essential to work closely with suppliers and service providers. Long-term collaboration and joint investments in green measures can lead to security for both suppliers and customers. The right supply network and alliances along the supply chain can offer a chance to overcome profitability difficulties in the coming years.

Industry-wide collaborations and standardization of components (e.g., batteries and data transparency by using smart labels and product passports) can help simplify downstream processes and reduce costs for reprocessing of material. The supplier network is key to the transition as it supports—or limits—the steep ramp-up curve needed to introduce new products into the BEV market. The suitability of the product portfolio and development ability and the size of the suppliers within the network, as well as the future content of their product portfolios, are determining factors. Some OEMs may need to extend their supplier base to ensure the ability to ramp up EVs (e.g., by securing sufficient battery cell supply).



#### 5. Be prepared to accelerate the shift to BEV even further by addressing the existing ICE vehicle fleet

Even though CO<sub>2</sub> emissions from new sales of vehicles have started to decline with increasing EV share, the global fleet of 1.25 to 1.6 billion cars consists predominantly of ICEVs (around 98.5%)<sup>39</sup> and likely will for some time to come. This clearly impedes the overarching target to reduce emissions to 1.5°C. In fact, today's climate policies often target new sales—except for some instruments that increase operational costs of petrol and diesel cars (such as CO<sub>2</sub> taxes on fuels). Furthermore, the inconsistency of global regulatory frameworks demands tailored business models, technological responses, and decarbonization strategies for different regional contexts.

The automotive ecosystem is already complex, and, in the future, there will likely be even more actors involved. As a result, cross-sector collaboration and joint activities, mainly with the power sector but also with basic materials production and recycling, should increase. A successful transformation also depends, therefore, on the progress of other sectors in providing green solutions at scale. As a result of these challenges, the majority of automotive companies may find it still difficult to establish a stringent sustainability strategy. Regulators will most likely be forced to drive the exchange of existing ICE global carpark. Resulting laws, penalties, taxes, and extended producer responsibilities represent possible additional complexity and cost burdens, which frontrunners should be better able to avoid. Possible return responsibilities regarding ICE vehicles and further scrapping premiums should not be ruled out. The earlier the shift to BEV happens, the less ICE vehicles will likely need to be managed in the long term.



#### 6. Manage the twofold challenge of decarbonization and profitability

The sustainable transformation of the automotive sector likely needs to scale, with profitability kicking in by 2030 as soon as decarbonization efforts accelerate. Management will likely be required to clearly drive the transition having a proper strategy and communications plan that involves various stakeholders from founders to investors to employees. This means that in addition to realizing cost-savings, profitability should be sought within old and new revenue streams. Passing on green price premiums to customers could help to cover additional costs that are connected to decarbonization. But this may be rather difficult to realize as vehicle and service prices rise and as sustainable practices become the new standard requirement anyway.

The prices of BEV and ICE will likely need to converge sooner rather than later. Early offerings and expansion of flexible service models like leasing, renting, or pay-per-use could drive profitability as their demand is expected to grow significantly. New revenue pools such as software-based vehicles, data monetization, and other digital assets should be built. Investors and supervisory boards may especially insist on and actively demand diversified offerings to help secure future profitability and existence.

In addition, new business areas are likely emerging around BEVs that represent new revenue sources for OEMs. Here, the use of vehicles over several life cycles in leasing/subscription/rental models is indispensable.<sup>40</sup> The monetization of data should also be considered in a structured manner as a new revenue source.

Market share can also grow through targeted mergers and acquisitions. As market volatility decreases, we will likely see more consolidation and absorption of identical business models.

## Conclusion

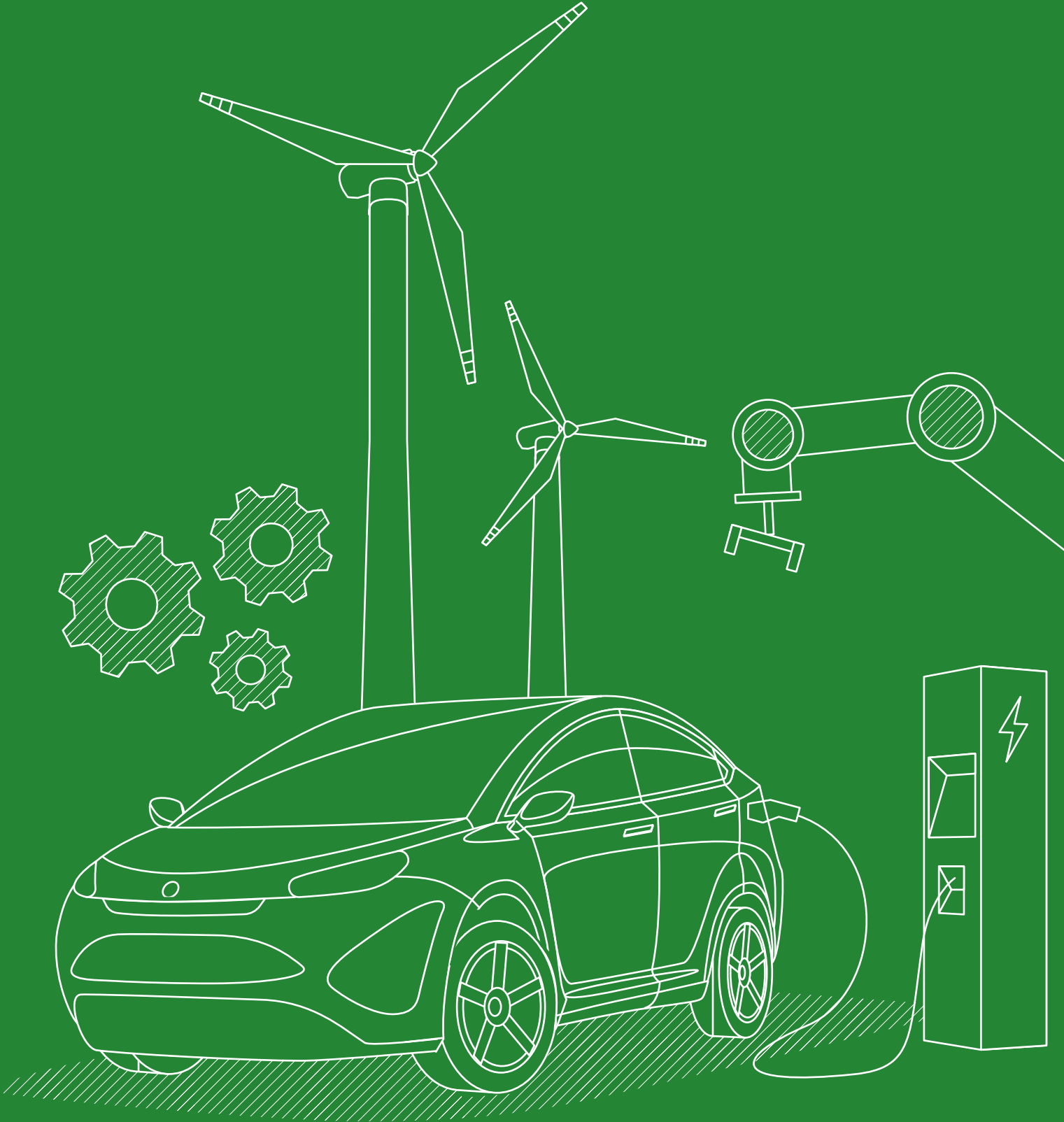
As indicated by the simulation, OEMs' core business will likely undergo significant changes over the next decade. Current market share and profits will likely be significantly impacted by climate change and sustainability issues. Even so, the goal for the automotive industry seems to be clear: to be compliant with the 1.5°C temperature target, transitioning hand-in-hand with future-oriented and sustainable business strategies that are both ecological and economical. It is necessary to decarbonize the entire value chain—which should be rebuilt around EVs. Interdependencies and impacts along the value chain, based on expected and validated market developments, move far beyond the carbon footprint impacting not only the core business and its product portfolio but also profitability models and the workforce.

While current decarbonization discussions are mainly driven by regulation, car manufacturers (including OEMs, suppliers, etc.) may need to take the wheel and play an active part in the solutions that help ensure reaching the net-zero goal. The industry has responded already as demonstrated by their ambitious near-term targets.

Nevertheless, long-term targets may still be needed (according to SBTi commitments). For example, some OEMs are already partly planning to phase out ICE production ahead of regulatory requirements. However, to put the targets into practice has proven difficult as the transformation requires large investments to ramp up EV capacity and a net-zero business model that is still not competitive as costs cannot be passed on to customers. For OEMs, the right strategic moves as well as endurance may be needed to help master the coming years successfully. Individual pathways and focus areas should be defined, based on the OEM's specific background and values as well as its long-term vision and mission, which could include the following aspirations:

- Become a decarbonization leader by massively investing in new business models that, combined with a strong brand image, could translate into a sustainable offering and leads the market.
- Set up strategic partnerships and joint collaborations with suppliers or extend the supplier base to help enable BEV ramp-up at scale and quickly make the BEV product range more economical.
- Survive the profitability dip by working actively with financial investors to fund the transformation under the best conditions and staying closely aligned to regulators to be up to speed when new regulations are enacted.

In order to prepare for the future, OEMs will likely have to evaluate their current operating models according to external market circumstances. In the face of uncertainty, discussing different options can permit us to map out clear paths to the future. This is by no means limited to qualitative observations. Using a structured holistic decarbonization model, we are able to show that quantitative insights on the P&L are possible, permitting us to provide sharp, qualitative views. In fact, this approach may help enable the decision-makers in today's automotive industry to take the necessary steps on a well-informed basis, shape the future of the industry and their own company, and continue to play a significant role in 2030 and beyond. Now is the time to start on the pathway to net-zero.



# 08. Technical appendix & limitations

## Pathway to net-zero model

The pathway to a net-zero model considers the market environment with two climate scenarios including regulatory implications and the general vehicle market. Along the value chain, the areas material, production,

usage and end-of-life are displayed. Here the impacts are evaluated for carbon emissions, P&L, and workforce.

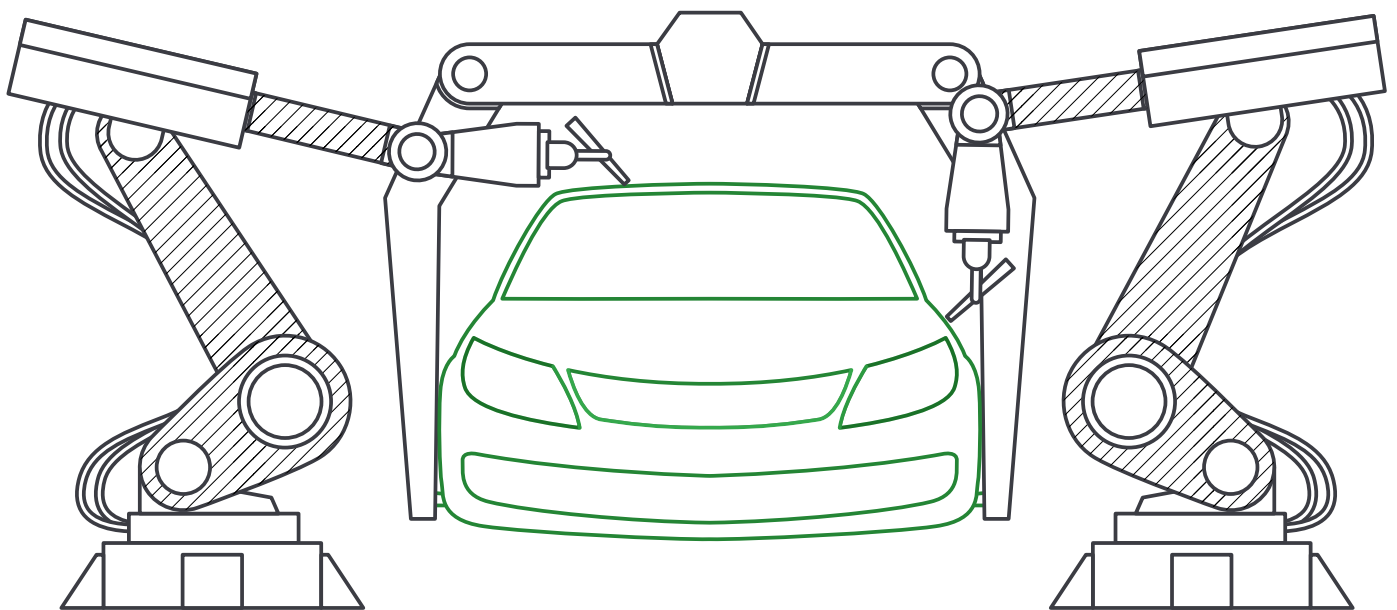
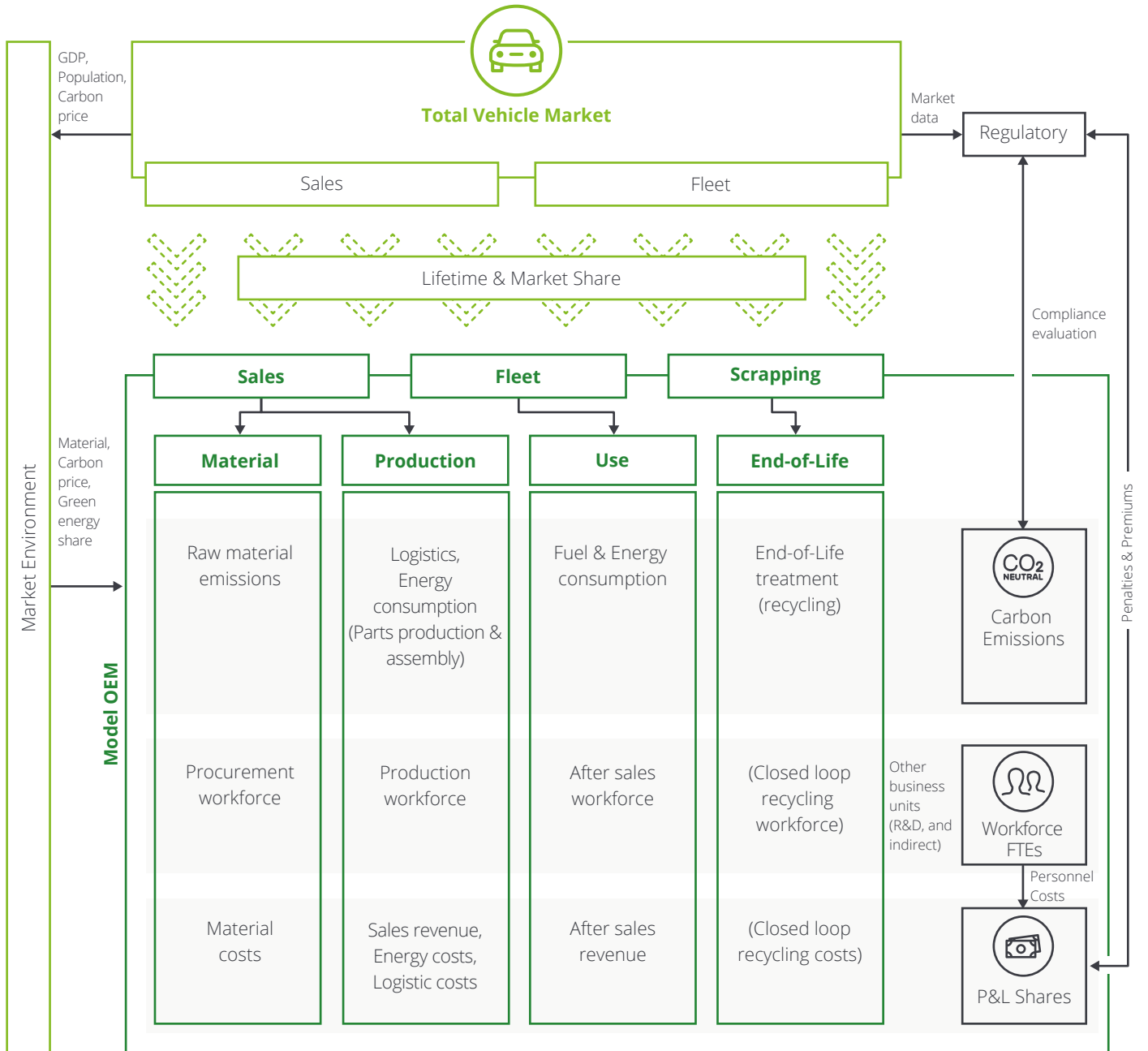




Fig. 22 – Pathway to net-zero model



■ Model Input  
 ■ Model Levers  
 ■ Model Output

## Climate scenarios

How might external factors develop over the next 30 years? One way to account for potential developments of climate, society and economy is to use the Shared Socio-economic Pathways (SSP) in combination with Representative Concentration Pathways (RCP). These SSP-RCP scenarios are widely established within climate science and build the core of the well-established IPCC reports.<sup>41</sup> Among the most important parameters defining these scenarios are renewable electricity availability, carbon prices, Gross Domestic Product (GDP), and population, which are all publicly available.<sup>42</sup>

This study models OEMs behavioral pathways for two SSP-RCP scenarios: firstly, a status quo scenario (SSP2-RCP4.5) of continuing historical patterns of global warming and societal development, resulting in ~ 3°C (2.1–3.5°C) global warming by the end of the century.<sup>43</sup> Second, a progressive scenario (SSP1-RCP1.9) of a sustainable future, reaching the goals of the Paris Agreement and limiting global warming to 1.5°C (1.0–1.8°C).

SSP/RCP data was used to model the different scenarios automotive companies might find themselves in over the next 30 years.

The Shared Socioeconomic Pathways (SSPs) describe different socioeconomic developments, and the Representative Concentration Pathways (RCPs) model different emissions pathways and the associated impact on the climate.<sup>44</sup>

Climate scenario data was available for OECD and Asia. Therefore, variables such as GDP, population, energy availability, and carbon price are identical for the United States and Germany and could not be differentiated.

## SBTi net-zero pathway

The carbon model follows the cross-sector pathway that is applicable to the automotive sector. Near-term targets and a long-term target were modeled to evaluate the decarbonization pathways against the average OEM's SBTi net-zero target.

Starting from a base year of 2018, near-term targets were set for every five-year timeframe with a -4.2% p.a. average minimum annual linear reduction rate for scope 1 and 2 and 4.2%/2.5% in the progressive/status quo scenarios. The long-term target was set to 2050 with a 90% reduction in scope 1, 2 and scope 3 compared to the base year.

However, the model does not cover carbon capture and storage measures and their associated costs to remove and neutralize residual emissions. Removal of residual emissions is vital to reach a true net-zero emissions level and OEMs are recommended to invest in removal technologies so that they are available to neutralize residual emissions at the long-term science-based target date.

Lastly, there is currently no sector decarbonization approach (SDA) for transport that allows companies to align their use-phase emissions targets for new road vehicles with 1.5°C pathways.<sup>45</sup> As automotive companies cannot submit scope 3 category 11 targets until 1.5°C-aligned pathways for new road vehicles are released, the cross-sector pathway was used.

## Regulatory assumptions

**In the Status Quo scenario, the following regulatory developments were assumed:**

- The set **sales ban of ICE & PHEV** in the EU by 2035 and an assumed ban in China by 2045 and in the whole United States by 2050, as the introduction of "no ICE" bans at all was deemed unrealistic. The ICE ban is expected to be earlier in China due to the higher share of cities, whose better charging infrastructure in turn may help facilitate eliminating ICE vehicles, and the political system in China that can facilitate a radical policy shift.
- The implemented **emissions trading systems** (ETS) in the United States, EU and China covering emissions-intensive industries such as power generation and the German ETS covering fuels used in transportation (diesel, gasoline). It was assumed that transport fuels will not be incorporated into the ETS in the United States and China.

- **Fleet emission standards:** Existing use-phase emissions standards for new vehicles sold were modeled following the legislation in the United States, EU, and China (in China in the form of the Corporate Average Fuel Consumption regulation). The EU fleet emissions standards set individual weight-based targets for OEMs based on the vehicles sold each year. The overarching target for cars is set to 95 gCO<sub>2</sub>/km and is to be reduced by 55% by 2030 and planned to reach 0 gCO<sub>2</sub>/km after the 2035 sales ban of ICE vehicles.<sup>46</sup> The standards also include an incentive mechanism for zero- and low-emission vehicles. The United States Environmental Protection Agency sets emissions standards for passenger cars and light trucks for Model Years (MY) 2023 to 2026.<sup>47</sup> Fleet wide CO<sub>2</sub> targets for cars are expected to be reduced from 103 gCO<sub>2</sub>/km (MY 2023) to 82 gCO<sub>2</sub>/km (MY 2026). The Chinese CAFC assesses fuel consumption and applies to vehicles with combustion engines.<sup>48</sup> The target set for this is based, among other things, on the weight of the vehicle and the number of seats, with an average target of about 117 gCO<sub>2</sub>/km in 2020 and about 93g CO<sub>2</sub>/km in 2025.

- **Purchase premiums:** For Germany, we expect the existing purchase premiums of ~ \$9,500 for BEVs and PHEVs to be gradually reduced and phased out by 2025 as the market for BEVs and charging infrastructure develops. For the United States, we modeled federal subsidies for EVs from 2023 to 2032 according to the Inflation Reduction Act of up to \$7,500.<sup>49</sup> For China, we anticipated that the governmental subsidies (federal and regional) of up to ~ \$3,500 per BEV were to be continued to 2025.

**The progressive scenario assumes at least the developments of the status quo scenario with the following additional hypotheses:**

- Sales bans of new ICE and PHEV were modeled in the United States (2050), Germany (2035) and China (2035).
- It was assumed that transport fuels will be included in the ETS of the EU, the Uni-

ted States and China starting from 2030. The implications of the recent (December 2022) introduction of EU ETS II, which could cover fuels used in transportation from 2027 in the EU, was not included for the German market in the model as the new systems were not introduced until after the analysis was finished. Instead, the regulatory assumption that fuels will be included in the ETS of the EU, United States and China starting from 2030 was used. Similarly, the implications of CBAM were not integrated in the regulatory assumptions of the model.

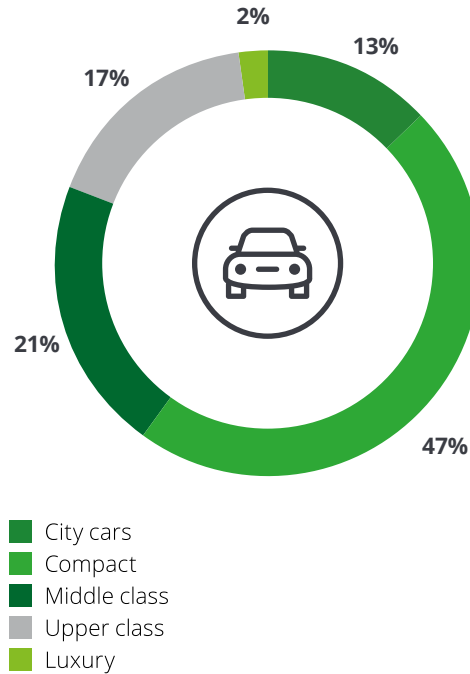
- Fleet emission standards were modeled as in the Status Quo scenario, with an additional tightening of the standards by 20 % in 2035 and in 2040 in the United States and a drop to 0 gCO<sub>2</sub>/km at the time of the ICE sales ban.
- Purchase premiums were modeled as in the status quo scenario.

**Deloitte EV Market Forecast Tool**

To predict the market penetration of alternative powered vehicles in various markets, we apply a proprietary developed total cost of ownership (TCO) based forecasting tool. Our tool calculates TCO values for different powertrains taking into account more than 20 relevant factors (e.g., acquisition costs, taxes, purchase premiums, operating costs, penalties, and residual values) over an assumed usage period. By comparing the TCO values across the considered powertrains and matching them to customer preferences (surveyed in the Deloitte Global Automotive Consumer Study), a relative distribution of vehicle sales among reflected powertrains is calculated. Applied on the S&P Global Mobility total vehicle sales forecast for each market, we get a market specific ramp-up curve for battery electric vehicles.

In our market forecast, the overall vehicle sales are clustered along five common vehicle segments reaching from city car and compact cars over middle- and upper-class vehicles to luxury cars. The segmentation is thereby mainly driven by vehicle size and

**Fig. 23 – Vehicle Segment Distribution**



sales price. The distribution of vehicle sales along these five segments is comparable across the considered markets (Germany, United States, and China), although the specific vehicle model composition of the segments in the markets vary.

The majority of vehicle sales (> 60%) accounts for compact and mid-size vehicles across all markets. Although we forecast a constant distribution of vehicle sales along the five segments over the years, we can expect an increase in bigger and heavier SUV-like vehicle models in all segments. Small and mid-sized SUVs in particular will likely gain in importance in the future.

### Automotive market development in the status quo scenario

The assumed automotive market developments are based on our Deloitte E-Mobility Model (database of December 2022) and S&P Global Mobility data (database of October 2022).

In the status quo scenario, we forecast a steady overall market (United States, Germany, and China) recovery (after the COVID-19 pandemic and chip crisis dips in 2020 and 2021) up to a new peak of approximately 48 million vehicle sales in 2035. This represents a slight increase compared to pre-COVID-19 sales in 2019 (42 million).<sup>50</sup> The overall market development is characterized in particular by a strong and growing Chinese market, which in our model accounts for approximately 60% of the vehicle sales considered in 2035. In contrast, market stagnation or even a slight decline in sales figures is forecast for the German and US automotive markets. After we pass the market peak in 2035, market stagnation or even a slight sales decrease is forecasted for China as well, based on increased market saturation.

In terms of the market transformation toward vehicles with alternative drive trains, we forecast different ramp-up curves for BEV market penetration in the considered regions. The fastest BEV ramp-up is predicted for Germany, accelerated primarily by the EU-wide ICE ban in place from 2035 onwards. After an initially slower shift towards alternative drives, the BEV ramp-up in the Chinese market may be accelerated significantly from 2030 onwards by rigorous regulation with high carbon surcharges on fuel and a general ICE ban starting 2045. While the BEV ramp-up in Germany and China is mainly characterized by sales restrictions on ICEs and decreasing prices for electric vehicles, the US market is likely developing more slowly in the direction of battery electric vehicles. The BEV ramp-up in the US market is mainly characterized by heterogeneous, state-specific regulations and long-term government subsidy programs, based on the Inflation Reduction Act (IRA), for electric vehicles until 2032, which shows

a strong focus on the local BEV industry. Given the status quo of legislation in the United States, due to the heterogeneous regulatory situation across US States, a comprehensive country-wide ICE ban is not expected until 2050 at the earliest.

Across all three regions considered in this study, in 2030, for the first time, more BEVs will likely be sold than ICEs, and in 2045, 90% of all vehicles sold will be fully electric.

Even with this sharp increase in sales of electric vehicles across all captured regions over the coming years, the effects on the vehicle in operation fleet will likely be limited in the near future. Our forecast is based on the assumption of an average vehicle usage period of 16 years, resulting in of 160,000 to 360,000 km depending on market and vehicle segment. This covers the entire vehicle life, from production to recycling, regardless of whether the vehicle is used in the primary sales market or has been exported.

Due to the long usage period of the vehicles sold and the current recovery of the overall automotive market, the number of ICE vehicles in operation will likely continue to rise despite falling sales shares. In the status quo scenario, we expect a peak of approximately 600 million ICE vehicles in operation in 2028. Even if more electric than ICE vehicles are sold as early as 2030, the BEV share will likely not account for 50% of the existing fleet until around 2040.

### Automotive market development in the Progressive scenario

As society moves towards better education, health, and economic growth, we expect a slight growth in population and overall increased GDP. In consequence, a moderate increase in sales is also expected for the automotive market. Market development up to the peak in 2035 is comparable to the status quo scenario, but with sales rising to around 49 million vehicles at the maximum. However, the expected decline in total sales by 2050 will be lower in this scenario, due to an increased population combined with higher purchasing power.

In contrast to the Status quo scenario, battery electric vehicles in the progressive scenario are expected to penetrate the market much faster from around 2030 onwards. While the regulatory framework in the considered markets will likely remain virtually unchanged until 2030, a higher carbon price in ETS for fuels used in transportation fuel will likely lead to a significant acceleration of BEV market penetration after 2030. The accelerated BEV ramp-up is primarily expected for the United States and Chinese markets, as the German market is already strongly geared towards electrification in the status quo due to strong regulations and an early ICE ban.

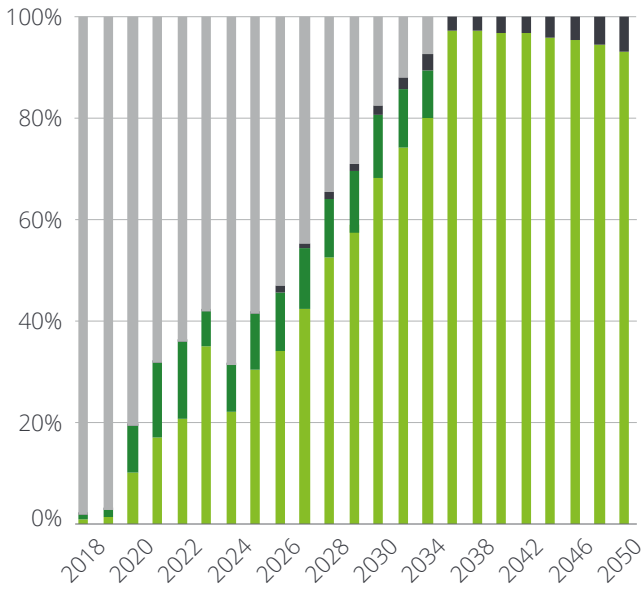
The impact of the carbon tax on fuels and ICE bans in selected states will likely significantly accelerate BEV sales in the US market after 2035. Since China has a strong and growing local BEV industry and regulations are rapidly and easily introduced for political reasons, we assume a much earlier ICE ban in China from 2035 onwards in a progressive world.

On a global (Germany, United States and China) level, the forecast for a progressive world indicates a BEV adoption rate of > 50% by 2030 and an accelerated ramp-up in the years after, resulting in a share of approximately 90% all electric vehicle sales by 2035.

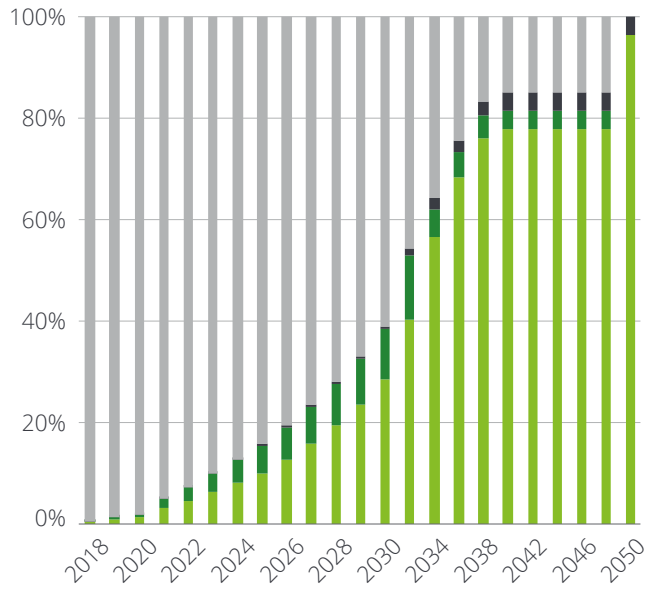
**Fig. 24 – Automotive market development in the Status Quo scenario**



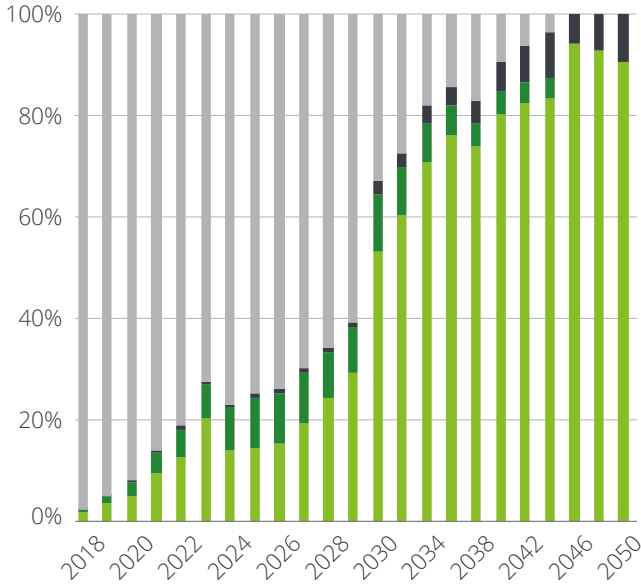
Market Share in %



Market Share in %



Market Share in %

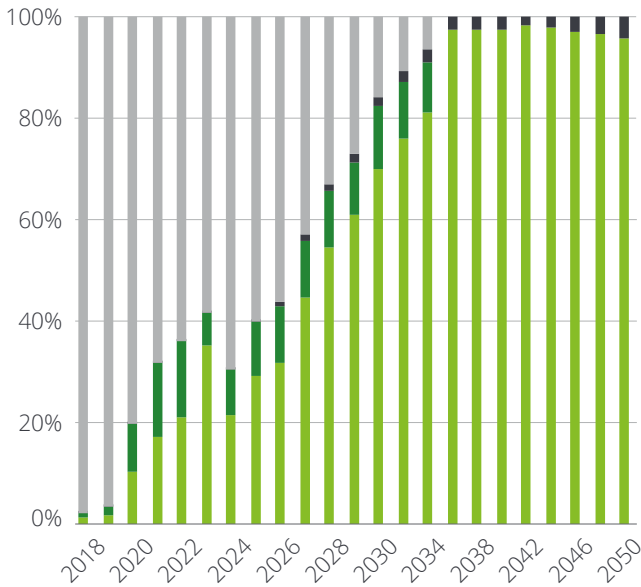


ICE BEV PHEV FC

**Fig. 25 - Drive train distribution per market (Progressive scenario)**



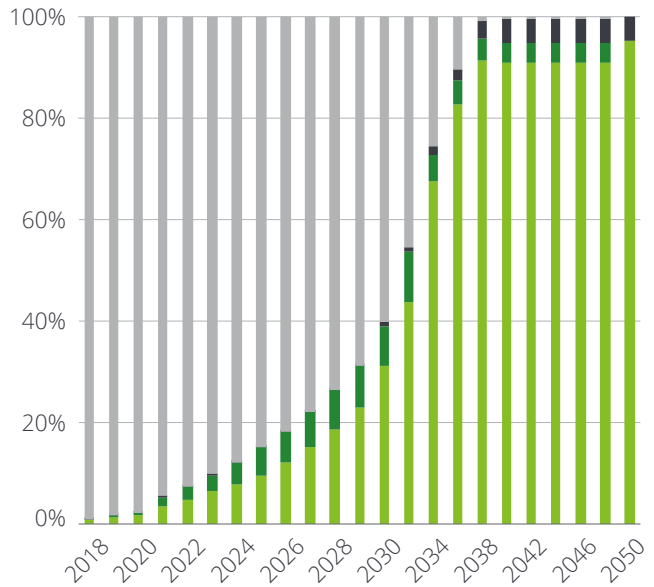
Market Share in %



**EV Incentives heavily reduced from 2024 onwards**



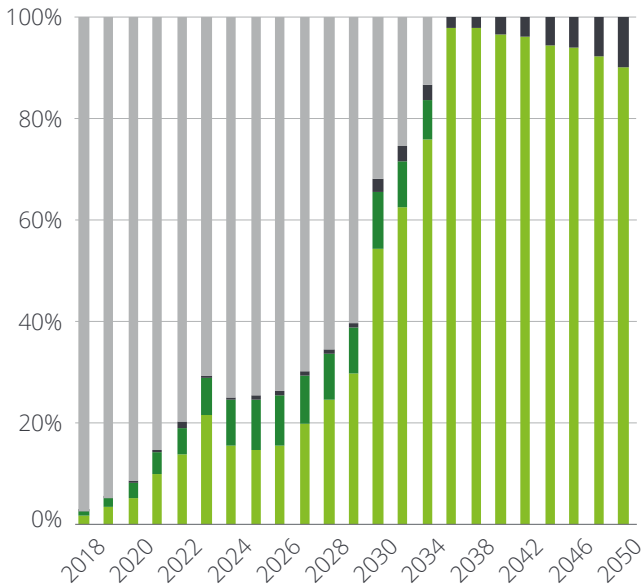
Market Share in %



**From 2035 onwards major increase of CO<sub>2</sub> prices on fuel**



Market Share in %



**Increased CO<sub>2</sub> prices on electricity from 2022  
CO<sub>2</sub> price increase on fuel from 2030 onwards**

ICE BEV PHEV FC

Even if the BEV market share in new car sales grows significantly faster in the Progressive scenario than in the status quo scenario, the effects on the existing fleet are also significantly delayed here. Also, in the Progressive scenario the ICE fleet will likely continue to grow until the end of the decade, peaking at around 600 million vehicles in 2029. We expect electric vehicles to account for more than 50% of the fleet in operation two years earlier than in the status quo scenario, starting in 2038. However, the accelerated BEV ramp-up is particularly noticeable for the period between 2040 and 2050. BEVs will likely already account for more than 85% of the existing fleet in 2045 and more than 90% in 2050.

**Carbon emissions**

The corporate carbon footprint modeled for this study covers all relevant scope categories for an automotive company, representing 99% of the total emissions. The calculation follows the requirements of the GHG Protocol Corporate Standard and includes all seven GHGs covered by the Kyoto Protocol – carbon dioxide (CO<sub>2</sub>), methane (CH<sub>4</sub>), nitrous oxide (N<sub>2</sub>O), hydrofluorocarbons (HFCs), perfluorocarbons (PCFs), sulphur hexafluoride (SF<sub>6</sub>), and nitrogen trifluoride (NF<sub>3</sub>).

**The following GHG Protocol Scope categories were included:**

- 1.1 Fuel consumption in stationary sources
- 1.2 Fuel consumption in mobile sources
- 3.1 Purchased goods and services
- 3.4 Upstream transportation and distribution
- 3.9 Downstream transportation and distribution
- 3.11 Use of sold products (well-to-wheel)
- 3.12 End-of-life treatment of sold products
- 3.13 Downstream leased assets

**The following GHG Protocol Scope categories were not included as they do not represent significant emission sources of an automotive manufacturer (combined <1%):**

- 1.3 Process emissions
- 1.4 Fugitive emissions
- 2.2 District heating
- 2.3 District cooling
- 2.4 Steam
- 3.2 Capital goods
- 3.3 Fuel- and energy-related activities (not included in scope 1 or scope 2)
- 3.5 Waste generated in operations
- 3.6 Business travel
- 3.7 Employee commuting
- 3.8 Upstream leased assets
- 3.10 Processing of sold products
- 3.14 Franchises
- 3.15 Investments

The accounting of transport-related emissions should be based on the principle of well-to-wheel. This means including both direct emissions from fuel combustion (tank-to-wheel) as well as upstream emissions from fuel production and fuel transport (well-to-tank).<sup>51</sup>

**Material** emissions are based on the extraction and production of steel, aluminum, polymers, electronics and battery per vehicle type and class purchased by the OEM (from raw material extraction to parts production). Material emissions of purchased secondary materials stem from recycling and treatment of waste material. From the main materials used in a vehicle, fluids, glass and other material types were excluded from the model to reduce complexity. The calculation of material emissions for purchased goods and services and the extrapolation of emission factors up to 2050 was based on emission factor databases and energy data from SSP-RCP scenarios. The emission factors for green materials were set to be constant, as they are already produced from 100% renewable energy. Therefore, the model is not accounting for changes in emission intensity of renewable energy. Material emission factors were extrapolated using green energy availability which does not account for other developments and innovation that could lower material emissions aside from the global shift to more green energy production.

**Production** emissions cover natural gas, biogas and electricity used in vehicle production (scope 1 and 2). It covers production processes at the OEM for all relevant processes, from pressing, body in white, paint shop to assembly. Additionally, a lump sum for inbound and outbound logistics emissions was added in production emissions covering emissions from transportation and distribution of products from tier 1 suppliers to OEM production sites and emissions from OEMs operations to the end consumer, including retail and storage. Emissions from upstream and downstream transportation are part of scope 3 emissions. However, to reduce complexity they were added to the emission bucket of production emissions and show up as scope 1 and 2 emissions in the model. Given the small share of logistics emissions, this was deemed acceptable.

**Usage** contains the well-to-wheel emissions caused during the use of the produced vehicles. Here, emissions from fuel and electricity production (well-to-tank) and tailpipe emissions from fuel combustion (tank-to-wheel) were considered.

**End-of-life** emissions caused in the end-of-life treatment cover waste disposal and treatment of products that reached the end of the usage phase. Waste disposal spans different methods such as landfill or combustion and treatment contains for example dis-assembly and recycling. Emissions from end-of-life treatment can be accounted in different ways. Two main calculation strategies are an open-loop and closed-loop approach. In the open-loop process, emissions from recycling are accounted in the end-of-life process and emissions from externally purchased secondary materials production are accounted in the upstream materials procurement. In a closed-loop process, however, emissions from recycling are only accounted in end-of-life, not for the procurement, due to the closed-loop process. The modeled average OEM is currently operating in an open-loop system which means that the OEM recycles with partners externally and not in-house. Hence, the treatment of scrap and waste material was accounted in scope 3.1. purchased goods and services. The calculation of landfill and energetic recycling emissions was based on emission factors from Ecoinvent 3.8. These factors are assumed to be constant until 2050. Note, that a possible second life of vehicle parts is not included.

The organizational boundaries of the CCF of the average OEM were set using the operational control approach as it is used by many OEMs and will likely be required by the new ESRS standards.<sup>52</sup> In this consolidation approach, a company accounts for 100% of emissions from operations over which itself or one of its subsidiaries has operational control. Since operating leases represent the majority of car leases, emissions from leased vehicles were accounted

for yearly in scope 3.13 Downstream leased assets following GHG Protocol guidelines for emissions accounting of leased assets.<sup>53</sup> Emissions were accounted for each reporting year based on the modelled OEM activities during the reporting year. Usage emissions from the OEMs own company cars (scope 1) and leased vehicles (scope 3) were accounted yearly in the year of the actual fuel consumption while usage emissions from sold vehicles were accounted once in the year of the vehicle sale for the entire expected lifetime of the sold vehicle. While this is the GHG Protocol requirement and the accounting base for corporate GHG reduction targets, the physical emissions of an ICE fleet occur in the 16 years of average lifetime, after the emissions were already accounted for. This leaves room for deviations of accounted emissions to actual emissions if the assumptions used for calculating estimated usage emissions (e.g., lifetime, mileage, use of e-fuels) prove to be false. Secondly, while the emissions were already accounted for to the OEM, the future might bring further regulation regarding the yearly emissions of a vehicle fleet an OEM has produced.

### Decarbonization levers

Table 3 describes our selected decarbonization levers in detail.



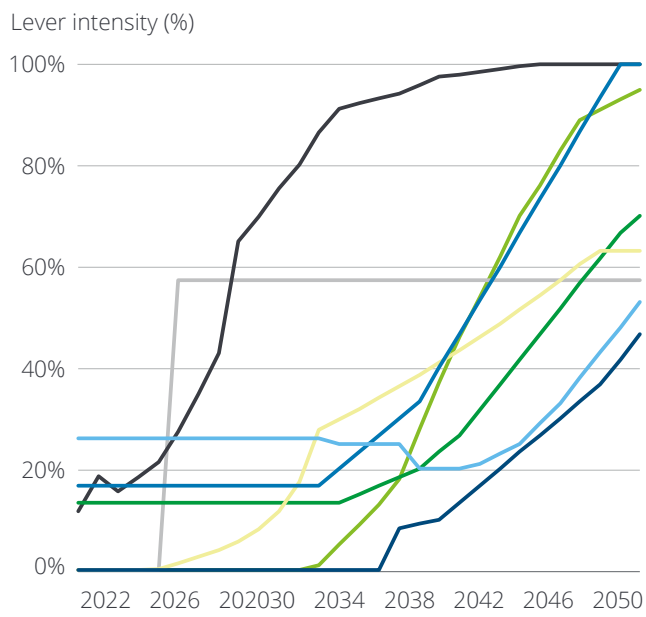
**Tab. 3 – Description of our main decarbonization levers**

Area	Name	Lifetime phase	Lever discription
Low carbon materials	Green materials	Material	Low carbon version of main materials and parts, including the material extraction, preparation, and parts processing at the supplier facilities. The processes need to be powered by energy from renewable sources instead of fossil energy sources like coal or natural gas to reach the decarbonization effect.
	Component weight reduction	Material Production Usage End-of-Life	Less material input or the use of alternative lightweight materials result in a reduced vehicle weight and can lead to efficiency gains with less fuel or electricity consumption during the usage phase. An example is represented by the partially replacement of steel with aluminum. Component weight reductions can lead to CO <sub>2</sub> -emission decreases in all reflected phases.
Green production & logistics	Green energy in production	Production End-of-Life	The production at the OEM is powered by electricity from renewable sources as well as by biogas for such processes as heating. The vehicle’s end-of-life processes, like recycling or refurbishment, are part of the OEM activities and can be covered by this lever. The energy supply could be secured by green energy contracts with energy providers or self-generated by the OEM, e.g., with solar panels on production site rooftops.
	Green logistics	Material Production	Use of low carbon transportation modes for inbound and outbound logistics. Contracts with logistics service providers for low carbon transports e.g., with electric trucks or sea and air freight that use synthetic fuels.
Product portfolio and operation	Green energy contracts	Usage	Ensuring a green electricity power supply from renewable sources for customers in the usage phase by offering green energy contracts/fuel cards e.g., in cooperation with energy service providers.
	E-fuels	Usage	Operation of remaining ICE vehicles with e-fuels in the usage phase instead of fossil-based fuels. The lever impact can be fostered as well by offering customers contracts/fuel cards e.g. in cooperation with fuel service stations.
	Model classes	Material, Pro- duction Usage End-of-Life	Shift to smaller vehicle model classes, reduced material inputs, light-weight materials and optimized vehicle design can generate efficiencies due to less fuel and electricity consumption in the usage phase.
	Drive train	Material Production Usage End-of-Life	Portfolio adjustments with a steady shift from vehicles with internal combustion engines to battery electric vehicles to avoid tailpipe emissions in the usage phase, if green electricity is used for operation.
Business models	Mobility services	Material Production Usage End-of-Life	OEM appears as a mobility service provider with leasing, pay-per-use and sharing offerings. Because of the OEM’s extended ownership, the usage phase can be influenced positively. This can lead to less carbon emissions as a result of e.g., ensured green electricity supply and less required vehicles on the market due to an optimized vehicle utilization.
	Energy services	Usage	The OEM appears as an energy service provider through vertical integration and offers green electricity to customers. The energy is created from renewable energy sources and offered e.g., in charging points, which are run by the OEM.
Circular Economy	Secondary Materials	Material	Increase of secondary (recycled) materials rate in sourcing with a focus on the main materials: aluminum, steel, polymer, electronics, and batteries.
	End-of-Life vehicle recycling	Material End-of-Life	Closed-loop recycling of end-of-life vehicles and replacement of virgin material in material sourcing and production. OEM could take over activities with regards to the circular economy or work closely with partners from the downstream supply chain.

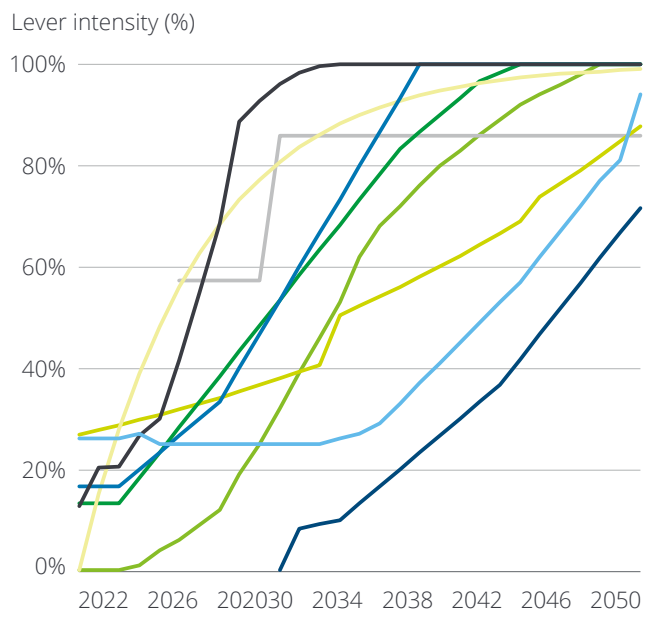
Levers were modeled with different intensity for frontrunner and good citizen behavior. Figure 26: Selected decarbonization levers with intensity; figure shows a selection of decarbonization levers and how their intensity was modeled over time.

**Fig. 26 - Selected decarbonization levers with intensity**

**good citizen**



**frontrunner**



- green materials
- component weight reduction
- biogas in production
- green electricity in production
- green logistics
- green energy contracts
- e-Fuels
- drivetrain
- secondary material

### Dilemma of the existing ICE fleet

Automotive companies have the most emissions in their downstream value chain. While the usage emissions of a sold vehicle are accounted for once for the entire life-time in the year of the vehicle sale, the fleet vehicles, above all ICE vehicles, continue to emit emissions every year.

Even though we look at a sharp increase in sales of electric vehicles across all captured regions over the coming years, the effects on the vehicle in operation fleet will likely be limited in the near future. Our forecast is based on the assumption of an average vehicle usage period of 16 years, resulting in 160,000 to 360,000 km depending on market and vehicle segment. This covers the entire vehicle life from production to recycling, regardless of whether the vehicle is used in the primary sales market or has been exported.

Due to the long usage period of the vehicles sold and the current recovery of the overall automotive market, the number of ICE vehicles in operation will likely continue to rise despite falling sales shares. In the Status Quo scenario we expect the peak of approximately 600 million ICE vehicles in operation in 2028 for the considered markets, China, United States and Germany. Even if more electric than ICE vehicles are sold as early as 2030, the BEV share will likely not account for 50% of the existing fleet until around 2040.

### Average OEM

The modeled OEM is calculated as an average OEM. Hence, it is fictive and cannot be directly linked to any existing OEM. The model can be tailored according to specific requests to provide individual insights.

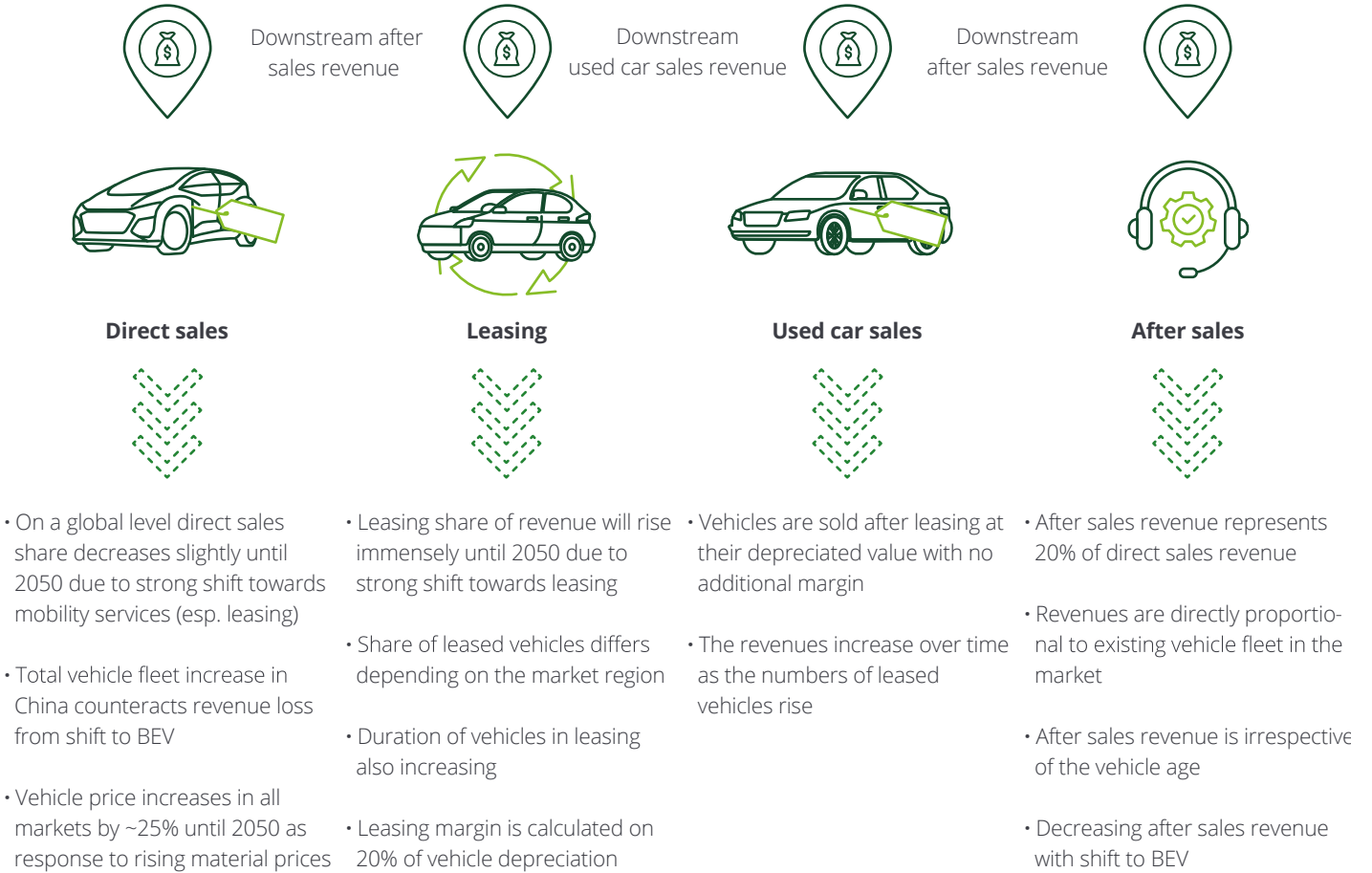
Modeling the OEM's P&L, the four revenue streams direct sales, leasing, used vehicle sales and after sales are considered. These revenue streams are interconnected and influence each other. For example, after sales revenue depends on vehicles sales and an increasing demand for flexible mobility services will likely have a significant impact on direct vehicles sales and used vehicle sales will result from previously leased vehicles.

As of today, direct sales represent the OEM's most important revenue stream, therefore profitability needs to be sought especially within this area. Vehicle prices of ICEs & BEVs are expected to merge by 2028.

On a global level it is expected that direct vehicle sales will break down by up to 30% until 2030 compared to the base year 2022. It is expected that vehicle prices will further increase in all markets in the upcoming years by 25% until 2050 as response to the costly transformation to a pure electric vehicle portfolio as well as to rising energy and material prices. BEV sales margins will likely be lower at first due to the high costs for electrification but will improve in time due to economies of scale in production. Luxury and upper-class vehicles may have higher margins than smaller vehicle classes.

As living circumstances change more rapidly, customers will likely demand more flexibility in their mode of vehicle use and become more open to convenient full-service/bundled services in the transport sector. Moreover, urbanization, increasing traffic congestion, and limited parking space availability is likely making private vehicle ownership a burden. With the increasing total cost of ownership (TCO) for vehicle possession, especially for BEV, customers are less willing to take on the residual value risk associated with car ownership. A strong demand for more flexible mobility services is expected in which up to 90% of the produced vehicles will likely be used. Especially in the European and US markets this shift is very likely to happen. Therefore, leasing revenues will likely increase significantly and overtake direct vehicle sales as the OEM's major revenue source in the next ten to fifteen years. Furthermore, we consider a small profit margin of 3% on the sales of used cars from leasing.

**Fig. 27 - Revenue sources**



**Price and cost developments**

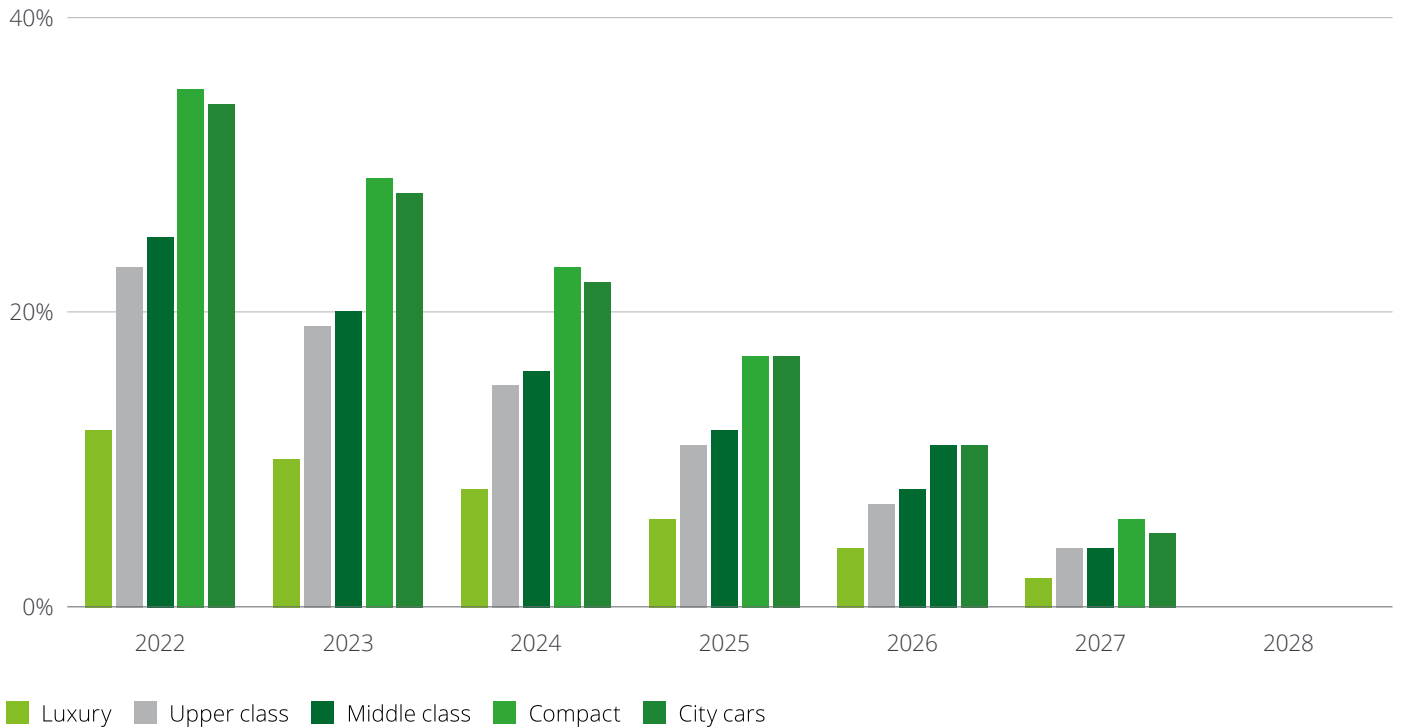
Assumed price developments are based on historic developments and future expectations but not fully predictable as global demand and supply can be influenced by unexpected global events.

Used prices are adjusted for inflation considering global historical inflation rates. Vehicle sales prices are differentiated per model class and region. It is expected that vehicle prices will further increase in all markets in the upcoming years by 25% until 2050 in response to the costly transformation to a pure electric vehicle portfolio as well as to rising energy and material prices.

Vehicle sales prices differ between ICE and electric drive train. Today, BEV vehicles are more expensive than comparable ICEs due to additional costs for the battery pack, missing economies of scale and additional R&D investments. Especially for vehicles in the compact class and city cars, the additional costs for the traction battery are very relevant today and thus often lead to significantly higher sales prices. Depending on the vehicle segment this markup today ranges from 12% within the luxury segment to up to 35% for city cars.

**Fig. 28 – Sales price markup for electric vehicle**

Sales price markup for electric vehicle in percentage



Even though the current geopolitical climate has led to higher battery prices lately, we expect prices for lithium-ion batteries will be halved during the next 15 years due to economies of scale, easier recycling, and a circular economy. With the shift from ICE to BEV, we assume that sales prices across all vehicle segments will have converged by 2028 at the latest.

The carbon price was taken from SSP/RCP data. The carbon price in the Status Quo scenario was not modified. However, the tremendous carbon price of up to 1,460 USD/tCO<sub>2</sub> in the progressive scenario was capped at 350 USD/tCO<sub>2</sub> to represent an ambitious but still realistic carbon price development.

Only the P&L account is mapped within the Pathway to net-zero model, not the OEM's balance sheet including investments. Higher leasing and production assets are reflected in the balance sheet, thus higher depreciation is P&L effective. The model also does not consider liabilities, which means that capital costs cannot be taken into account in P&L analysis.

Only leasing is considered in the model as a flexible and financial mobility service and therefore not representative for other services such as renting or pay-per-use.

Material costs currently represent the biggest part of COGS and in P&L in general and are assumed to grow further, up to 45% in 2050, considering price developments for aluminum, steel, polymers, and electronics. Especially sustainably processed material versions are more expensive in the next years due to green surcharges amounting up to 20% as i.e. green steel is more expensive than conventionally processed steel and extra costs will be added to the purchasing price. These surcharges will likely disappear when prices for green energy reach similar or even lower cost structures compared to fossil-fuel based energy sources. This can be reached due to global expansion of the renewable energy sources sector and further accelerated with regulatory driven actions. Also, the OEM's production process costs could

be impacted by that, in which electricity and gas is consumed. Batteries represent an exception in the material COGS, whose prices are expected to halve in time because of productivity gains, standardization, and higher recycling rates.

Personnel costs may also decline because of the above-mentioned workforce developments in figure 10 and 15.

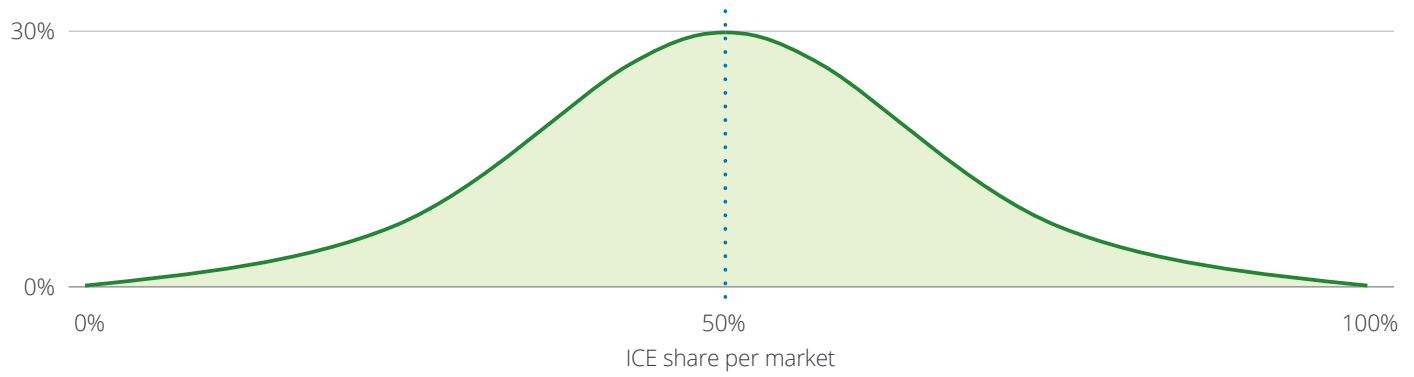
In the logistics category, costs for global, multi-modal transportation of materials, components, and produced vehicles are expected to rise with intensifying carbon regulatory and pricing on fossil-fuel based transportation modes. Sustainable modes of transportation will likely also be more costly at first but fall in time with increasing market offerings by logistics service providers, as the green transformation will also take place in the logistics area.

Changing consumer behavior and growing demand for flexible mobility services could also have an impact on the depreciation and amortization of an OEM. Depreciation costs for self-owned vehicles are expected to multiply until 2050 as the leasing and other flexible mobility service model rates rise.

Depending on the OEM's strategy and operations, depreciation for production assets could more than double during the coming years (Frontrunner with Aggressive approach). This is due to parallel BEV and ICE production and the steady wind down of old ICE plants and the ramp up of BEV production machinery, with the ramp-up and -down costs occurring as scaling effects for vehicles have not yet been achieved. Long transition periods from ICE to BEV can require enormous complexity management cost. Moreover, costs for inventory, production variants, quality assurance, and additional machinery will likely drive costs. For example, due to long ICE spare parts obligations, a cost increase for inventory and logistics may be expected. In addition, procurement costs will likely rise, because many parts need to be actively managed.

**Fig. 29 – Complexity costs markup in percentage**

Complexity Factor (Complexity Factor is based on a scaled normal distribution)



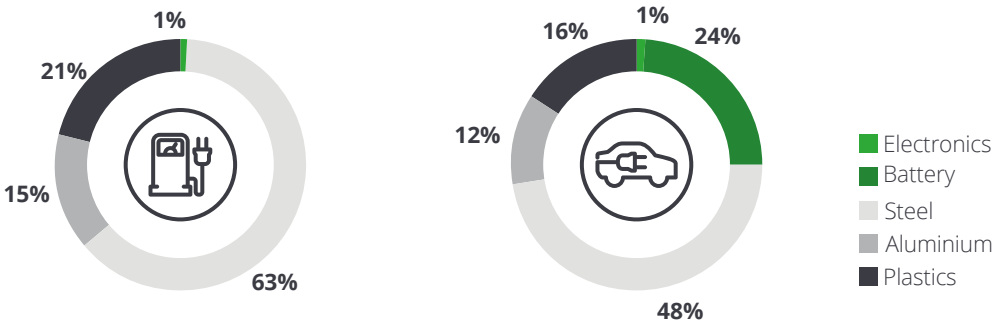
In this context, R&D and SG&A costs are also assumed to rise with the transition and increasing electric vehicle production and revenue across all sources. Moreover, costs for recruiting and retraining skilled personnel will likely rise. Other operating expenses could be affected especially with regards to penalties and further regulatory-driven cost that will likely have a higher impact in time.

**Vehicle Composition by material weight**

The following materials were considered with different composition per vehicle type and class: steel, aluminum, polymers, electronics, and batteries. From the main materials used in a vehicle, fluids, glass, and other material types were excluded from the model to reduce complexity. Approximate vehicle material composition, therefore, means that there is no exact calculation of material shares and emissions. Energy demand for battery in parts production not considered specifically; calculation differentiates ICE compared to BEV and PHEV only via their vehicle weights.

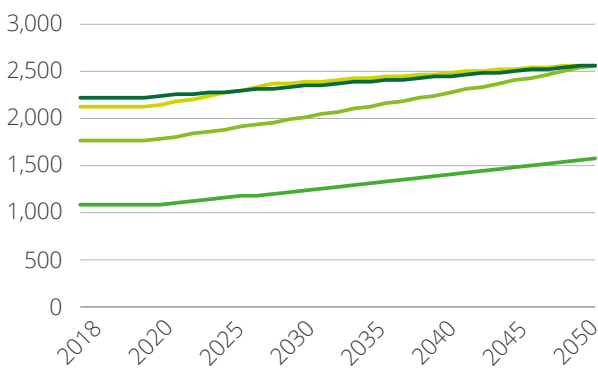
**Fig. 30 – Vehicle composition**

**Vehicle composition by material weight**

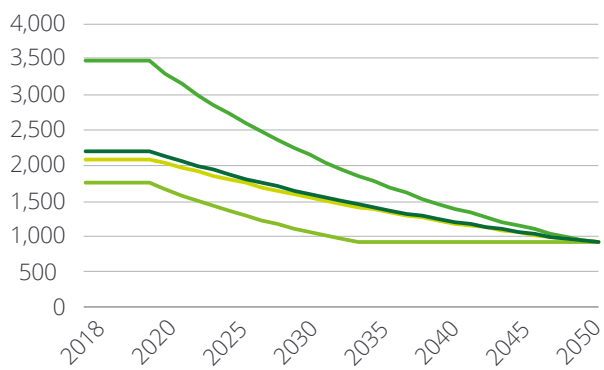


**Price developments over time**

Steel price (\$ per ton)



Battery prices (\$ per ton)

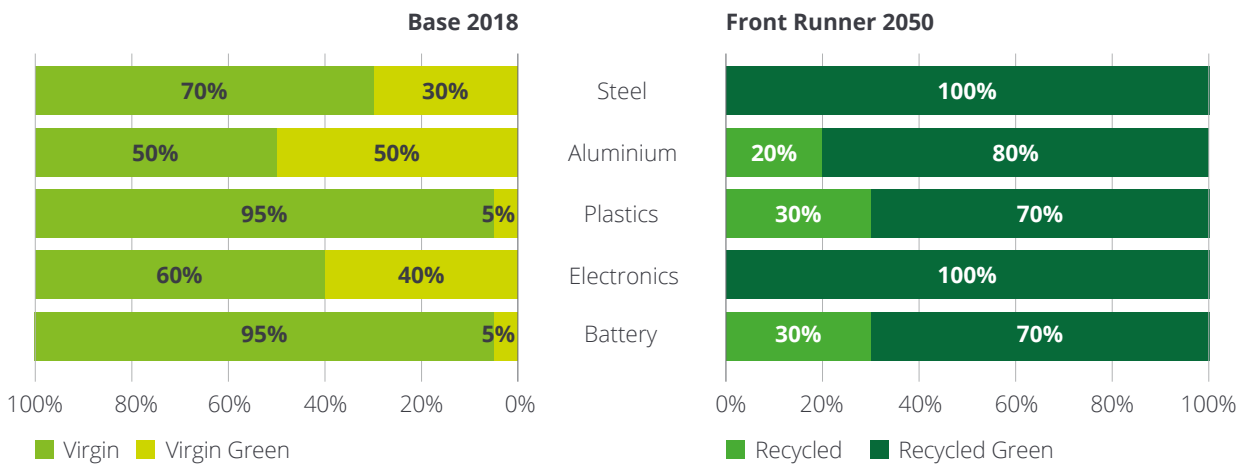


Virgin = External Recyclt    Virgin Green  
Internal Recycled    Recycled Green

Virgin    Virgin Green  
Internal Recycled    Recycled Green

**Material type purchase composition**

Selected examples





**Workforce**

The calculation approach for the workforce is based on a multiple linear regression. The input data originates from different financial statements of OEMs from 2017 to 2021 and contains the number of employees and BEV/ICE/PHEV rates as well as car sales per year. In combination with the percentage distribution of OEM departments (Deloitte Global assumption), linear regression factors for the number of employees were calculated. These factors comprise a variable (per vehicle) for employees per department and drive train as well as a fixed component including number of employees independent of expected vehicle sales. The department structure is identical for all three markets (China, Germany, and the United States). Further, the input and output data show the actual number of employees at the OEM not FTE.

**Abbreviations**

CO <sub>2</sub> / CO <sub>2</sub> e	carbon dioxide / carbon dioxide equivalent
COGS	Cost of goods sold
BEV	Battery electric vehicle
EBIT	Earning before interest and taxes
GHG	Greenhouse gases
ICE	Internal combustion engine
OEM	Original equipment manufacturer
PHEV	Plug-in hybrid electric vehicle
SBTi	Science Based Targets initiative

# Sources

01. World Business Council for Sustainable Development and World Resources Institute, A Corporate Accounting and Reporting Standard, The Greenhouse Gas Protocol, 2004, <https://ghgprotocol.org/sites/default/files/standards/ghg-protocol-revised.pdf>.
02. International Energy Agency, World Energy Outlook 2022, 2022, <https://iea.blob.core.windows.net/assets/830fe099-5530-48f2-a7c1-11f35d510983/WorldEnergyOutlook2022.pdf>.
03. International Energy Agency, Cars and Vans Tracking Report, 2022.
04. World Business Council for Sustainable Development and World Resources Institute, A Corporate Accounting and Reporting Standard, The Greenhouse Gas Protocol, 2004, <https://ghgprotocol.org/sites/default/files/standards/ghg-protocol-revised.pdf>.
05. United Nations, "7. d) Paris Agreement", Paris, December 12, 2015, [https://treaties.un.org/pages/ViewDetails.aspx?src=TREATY&mtdsg\\_no=XXVII-7-d&chapter=27&clang=\\_en](https://treaties.un.org/pages/ViewDetails.aspx?src=TREATY&mtdsg_no=XXVII-7-d&chapter=27&clang=_en), accessed August 22, 2022.
06. United Nations, "The Paris Agreement. What is the Paris Agreement". <https://unfccc.int/process-and-meetings/the-paris-agreement/the-paris-agreement>, accessed August 22, 2022.
07. Europäische Kommission, „EU-Emissionshandelssystem (EU-EHS)“, [https://climate.ec.europa.eu/eu-action/eu-emissions-trading-system-eu-ets\\_de](https://climate.ec.europa.eu/eu-action/eu-emissions-trading-system-eu-ets_de), accessed March 13, 2023.
08. European Commission, "EU taxonomy for sustainable activities", [https://finance.ec.europa.eu/sustainable-finance/tools-and-standards/eu-taxonomy-sustainable-activities\\_en](https://finance.ec.europa.eu/sustainable-finance/tools-and-standards/eu-taxonomy-sustainable-activities_en), accessed March 14, 2023.
09. Sandra Wappelhorst, Update on government targets for phasing out new sales of internal combustion engine passenger cars, International council on clean transportation, 2021, [https://theicct.org/sites/default/files/publications/update-govt-targets-ice-phaseouts-jun2021\\_0.pdf](https://theicct.org/sites/default/files/publications/update-govt-targets-ice-phaseouts-jun2021_0.pdf).
10. Canalys, Global EV sales up 63% in H1 2022, with 57% of vehicles sold in Mainland China, August 2022, [https://canalys-prod-public.s3.eu-west-1.amazonaws.com/static/press\\_release/2022/1520304562Electric-Vehicle-sales-H1-2022.pdf](https://canalys-prod-public.s3.eu-west-1.amazonaws.com/static/press_release/2022/1520304562Electric-Vehicle-sales-H1-2022.pdf).
11. The International Council on Green Transportation, "Internal combustion engine phase-outs", 2022, <https://theicct.org/ice-phase-outs/>, accessed March 17, 2023.
12. World Bank, "Carbon Pricing Dashboard", 2013, [https://carbonpricingdashboard.worldbank.org/map\\_data](https://carbonpricingdashboard.worldbank.org/map_data), accessed March 17, 2023.
13. United States Environmental Protection Agency, "Regulations for Greenhouse Gas Emissions from Passenger Cars and Trucks", 2023, <https://www.epa.gov/regulations-emissions-vehicles-and-engines/regulations-greenhouse-gas-emissions-passenger-cars-and>, accessed March 17, 2023.
14. European Commission, Communication from the Commission to the European Parliament, the European Council, the Council, the European Economic and Social Committee and the committee of the regions. The European Green Deal, 2019, [https://eur-lex.europa.eu/resource.html?uri=cellar:b828d165-1c22-11ea-8c1f-01aa75ed71a1.0002.02/DOC\\_1&format=PDF](https://eur-lex.europa.eu/resource.html?uri=cellar:b828d165-1c22-11ea-8c1f-01aa75ed71a1.0002.02/DOC_1&format=PDF).
15. European Commission, Proposal for a Regulation of the European Parliament and of the Council amending Regulation (EU) 2019/631 as regards strengthening the CO<sub>2</sub> emission performance standards for new passenger cars and new light commercial vehicles in line with the Union's increased climate ambition, 2022, [https://eur-lex.europa.eu/legal-content/EN/TXT/PDF/?uri=CONSIL:ST\\_14932\\_2022\\_INIT&from=EN](https://eur-lex.europa.eu/legal-content/EN/TXT/PDF/?uri=CONSIL:ST_14932_2022_INIT&from=EN).
16. European Commission, Revision of the EU Emissions Trading System - Ordinary legislative procedure: first reading, 2022, [https://www.europarl.europa.eu/doceo/document/TA-9-2022-0246\\_EN.pdf](https://www.europarl.europa.eu/doceo/document/TA-9-2022-0246_EN.pdf).
17. Ministry of Foreign Affairs of the People's Republic of China, "Statement by H.E. Xi Jinping President of the People's Republic of China At the General Debate of the 75th Session of The United Nations General Assembly", 2020, [https://www.fmprc.gov.cn/mfa\\_eng/wjdt\\_665385/zyjh\\_665391/202009/t20200922\\_678904.html](https://www.fmprc.gov.cn/mfa_eng/wjdt_665385/zyjh_665391/202009/t20200922_678904.html), accessed March 17, 2023.
18. International Carbon Action Partnership, China National ETS. Fact Sheet, 2022, [https://icapcarbonaction.com/system/files/ets\\_pdfs/icap-etsmap-factsheet-55.pdf](https://icapcarbonaction.com/system/files/ets_pdfs/icap-etsmap-factsheet-55.pdf).
19. Ministry of Industry and Information Technology, "Passenger car enterprise average fuel consumption and new energy vehicle credit parallel management method", 2020, [https://www.miit.gov.cn/zwgk/zcwj/flfg/art/2020/art\\_2337a6d7ca894c5c8e8483cf9400ecdd.html](https://www.miit.gov.cn/zwgk/zcwj/flfg/art/2020/art_2337a6d7ca894c5c8e8483cf9400ecdd.html), accessed March 17, 2023.
20. <https://ghgprotocol.org/sites/default/files/standards/ghg-protocol-revised.pdf>, p. 25 (14.03.2023)
21. Science Based Targets, "Companies taking action", <https://sciencebasedtargets.org/companies-taking-action>, accessed February 1, 2023.
22. Deloitte, "Deloitte Global Automotive Consumer Study 2023. Die wichtigsten Trends in der Automobilindustrie aus Sicht der Konsumenten", 2023, <https://www2.deloitte.com/de/de/pages/consumer-industrial-products/articles/global-automotive-consumer-study.html>, accessed March 17, 2023.
23. International Energy Agency, "Global EV Data Explorer", 2022, <https://www.iea.org/data-and-statistics/data-tools/global-ev-data-explorer>, accessed January 24, 2023.
24. Deutsche Bundesregierung, Mehr Fortschritt wagen. Bündnis für Freiheit, Gerechtigkeit und Nachhaltigkeit. Koalitionsvertrag 2021- 2025, 2021.
25. S&P Global Mobility, "Light vehicles sales", 2022, <https://www.spglobal.com/mobility/en/products/automotive-light-vehicle-sales-forecasts.html>, accessed December 12, 2022.
26. Deloitte Consulting GmbH. (2022). Proprietary forecasting tool [Database]. Accessed on 19 December 2022
27. World Business Council for Sustainable Development and World Resources Institute, A Corporate Accounting and Reporting Standard, The Greenhouse Gas Protocol, 2004, <https://ghgprotocol.org/sites/default/files/standards/ghg-protocol-revised.pdf>.
28. For details see chapter 03 – Average OEM in 2022.
29. James Eagle, "Animation: How the Mobile Phone Market Has Evolved Over 30 Years", Visual capitalist, 2022, <https://www>.

- visualcapitalist.com/cp/how-mobile-phone-market-has-evolved-since-1993/, accessed January 26, 2023.
30. Gartner, "Market Share: PCs, Tablets and Mobile Phones, All Countries, 4Q14 Update", 2014, <https://www.gartner.com/document/code/274737?ref=dochist>, accessed January 27, 2023.
  31. Camera and Images Products Association (CIPA), "Total Shipments of Cameras and Interchangeable Lenses", 201, <https://www.cipa.jp/stats/documents/common/cr200.pdf>, accessed January 25, 2023.
  32. European Commission, "CO<sub>2</sub> emission performance standards for cars and vans", [https://climate.ec.europa.eu/eu-action/transport-emissions/road-transport-reducing-co2-emissions-vehicles/co2-emission-performance-standards-cars-and-vans\\_en#penalties-for-excess-emissions](https://climate.ec.europa.eu/eu-action/transport-emissions/road-transport-reducing-co2-emissions-vehicles/co2-emission-performance-standards-cars-and-vans_en#penalties-for-excess-emissions), accessed February 9, 2023.
  33. Based on vehicle sales of 124,000 vehicles in 2025 and the assumption that German sales represent 20% of total EU sales of the OEM
  34. Europäische Kommission, „CO<sub>2</sub>-Emissionsnormen für Personenkraftwagen und leichte Nutzfahrzeuge“, [https://climate.ec.europa.eu/eu-action/transport-emissions/road-transport-reducing-co2-emissions-vehicles/co2-emission-performance-standards-cars-and-vans\\_de](https://climate.ec.europa.eu/eu-action/transport-emissions/road-transport-reducing-co2-emissions-vehicles/co2-emission-performance-standards-cars-and-vans_de), accessed February 28, 2023.
  35. Financial market participants, personal expert interview, January 11, 2023.
  36. John Caramichael and Andreas Rapp, "The Green Corporate Bond Issuance Premium," International Finance Discussion Papers, no. 1346 (2022), <https://doi.org/10.17016/IFDP.2022.1346>
  37. Deloitte, Quantifying ESG- How ESG implementation impacts key valuation metrics, 2023, [https://www2.deloitte.com/content/dam/Deloitte/be/Documents/mergers-acquisitions/be\\_quantifying\\_esg\\_report\\_en\\_.pdf](https://www2.deloitte.com/content/dam/Deloitte/be/Documents/mergers-acquisitions/be_quantifying_esg_report_en_.pdf).
  38. Deloitte, Work toward net zero- The rise of the Green Collar workforce in a just transition, 2022, <https://www.deloitte.com/global/en/issues/climate/work-toward-net-zero.html>, accessed March 15, 2023.
  39. Based on EMIS Database. by Oxford Economics containing biggest markets
  40. Future of Automotive Mobility <https://www2.deloitte.com/de/de/pages/consumer-industrial-products/articles/future-of-automotive-mobility.html>
  41. Valérie Masson- Delmotte et al., Climate change 2021: The physical science base, (Switzerland: Intergovernmental Panel on Climate Change, 2021), [https://www.ipcc.ch/report/ar6/wg1/downloads/report/IPCC\\_AR6\\_WGI\\_SPM\\_final.pdf](https://www.ipcc.ch/report/ar6/wg1/downloads/report/IPCC_AR6_WGI_SPM_final.pdf).
  42. Keywan Riahi et al., "The Shared Socioeconomic Pathways and their energy, land use, and greenhouse gas emissions implications: An overview", Global Environmental Change, no. 42 (2017): pp. 153-168. <https://doi.org/10.1016/j.gloenvcha.2016.05.009>.
  43. Brian C. O'Neill et al., "The roads ahead: Narratives for shared socioeconomic pathways describing world futures in the 21st century", Global Environmental Change, no. 42 (2017): pp. 169-180. <https://doi.org/10.1016/j.gloenvcha.2015.01.004>.
  44. *ibid.*
  45. Science Based Targets, "Guidance for the transport sector", <https://sciencebasedtargets.org/sectors/transport#our-updated-oems-policy>, accessed March 12, 2023.
  46. European Commission, Proposal for a Regulation of the European Parliament and of the Council amending Regulation (EU) 2019/631 as regards strengthening the CO<sub>2</sub> emission performance standards for new passenger cars and new light commercial vehicles in line with the Union's increased climate ambition, 2022, [https://eur-lex.europa.eu/legal-content/EN/TXT/PDF/?uri=CONSIL:ST\\_14932\\_2022\\_INIT&from=EN](https://eur-lex.europa.eu/legal-content/EN/TXT/PDF/?uri=CONSIL:ST_14932_2022_INIT&from=EN).
  47. United States Environmental Protection Agency, "Regulations for Greenhouse Gas Emissions from Passenger Cars and Trucks", 2023, <https://www.epa.gov/regulations-emissions-vehicles-and-engines/regulations-greenhouse-gas-emissions-passenger-cars-and>, accessed March 17, 2023.
  48. Ministry of Industry and Information Technology, "Passenger car enterprise average fuel consumption and new energy vehicle credit parallel management method", 2020, [https://www.mii.gov.cn/zwggk/zcwj/flfg/art/2020/art\\_2337a6d7ca894c5c8e8483cf9400ecdd.html](https://www.mii.gov.cn/zwggk/zcwj/flfg/art/2020/art_2337a6d7ca894c5c8e8483cf9400ecdd.html), accessed March 17, 2023.
  49. The White House, Building a clean energy economy: a guidebook to the Inflation Reduction Act's investments in clean energy and climate action, 2023, <https://www.whitehouse.gov/wp-content/uploads/2022/12/Inflation-Reduction-Act-Guidebook.pdf>.
  50. S&P Global Mobility, "Light vehicles sales", 2022, <https://www.spglobal.com/mobility/en/products/automotive-light-vehicle-sales-forecasts.html>, accessed December 12, 2022.
  51. Science Based Targets, SBTi Corporate net-zero standard, 2021, p. 51, <https://sciencebasedtargets.org/resources/files/Net-Zero-Standard.pdf>.
  52. EFRAG, Draft European sustainability reporting standards – Explanatory note of how draft ESRS take account of the initiatives and legislation listed in Article 1(8) of the CSRD adding article 29 (b)- 5 to the Accounting Directive, 2022, [https://www.efrag.org/Assets/Download?assetUrl=%2Fsites%2Fwebpublishing%2F-SiteAssets%2F03%2520Explanatory%2520note%2520Fist%2520set%2520of%2520ESRS%2520Article%252029%2520b\\_last.pdf](https://www.efrag.org/Assets/Download?assetUrl=%2Fsites%2Fwebpublishing%2F-SiteAssets%2F03%2520Explanatory%2520note%2520Fist%2520set%2520of%2520ESRS%2520Article%252029%2520b_last.pdf).
  53. The Greenhouse Gas Protocol, Categorizing GHG Emissions Associated with Leased Assets Appendix F to the GHG Protocol Corporate Accounting and Reporting Standard – Revised Edition, 2016, [https://ghgprotocol.org/sites/default/files/standards\\_supporting/Categorizing GHG Emissions from Leased Assets.pdf](https://ghgprotocol.org/sites/default/files/standards_supporting/Categorizing%20GHG%20Emissions%20from%20Leased%20Assets.pdf).

# Contacts



**Dr. Harald Proff**

Partner  
Global Automotive Sector Lead  
Consulting  
hproff@deloitte.de



**Prof. Dr. Bernhard Lorentz**

Global Consulting Sustainability & Climate  
Strategy Leader  
blorentz@deloitte.de



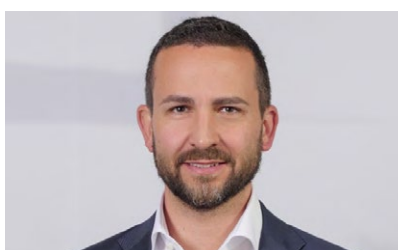
**Sebastian Pfeifle**

Partner  
Global Automotive Mobility Lead | Consulting  
spfeifle@deloitte.de



**Holger Weuste**

Partner  
Global Lead Client Service  
hweuste@deloitte.de



**Dr. Nick Helbig**

Partner  
Global Lead Client Service  
nhelbig@deloitte.de



**Benedikt Middendorf**

Director  
Automotive Mobility | Consulting  
bmiddendorf@deloitte.de



**Cathleen Gutglück**

Senior Manager  
Sustainability Automotive Lead  
Risk Advisory  
cgutglueck@deloitte.de



**Corina Cruceru-Weisbrod**

Manager  
Automotive Transformation Consulting  
ccruceru@deloitte.de



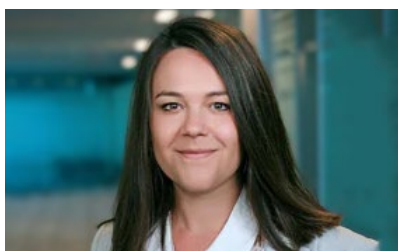
**Ciprian Gavriliu**

Tax Partner  
Leader of the Automotive Industry  
Deloitte Romania  
cgavriliu@deloittece.com



**Sorin Elisei**

Risk Advisory Director  
Leader of the Sustainability Practice  
Deloitte Romania  
selisei@deloittece.com



**Flóra Borek**

Risk Advisory Manager  
Sustainability & Climate Services  
Deloitte Hungary  
fborek@deloittece.com

# Acknowledgements

**A special thanks to the following individuals who provided continuous support to help establish the model and make this study possible:**

Maximilian Burkhalter (Senior Consultant, Consulting, Deloitte Germany)

Gurbet Fidan (Senior Consultant, Consulting, Deloitte Germany)

Tanja Schäfer (Senior Consultant, Risk Advisory, Deloitte Germany)

Benedikt Schlüter (Senior Consultant, Consulting, Deloitte Germany)

Leah Hubbermann (Consultant, Consulting, Deloitte Germany)

Niklas Lee (Consultant, Consulting, Deloitte Germany)

Sophie Rubin (Consultant, Risk Advisory, Deloitte Germany)

# Senior input & guidance

Andreas Emmert (Partner, Financial Advisory, Deloitte Germany)

Crunelle Guillaume (Partner, Audit & Assurance, Deloitte France)

Marcus Götz (Partner, Risk Advisory, Deloitte Germany)

Jeff Jia Wen Mou (Partner, Deloitte China)

Lars Essers (Director, Risk Advisory, Deloitte Germany)

Christoph Hieber (Director, Workforce Transformation, Consulting, Deloitte Germany)

Lydia Neuhuber (Director, Deloitte Sustainability & Climate, Deloitte Germany)

Ryan Robinson (Automotive Research Leader, Deloitte Canada)



Deloitte refers to one or more of Deloitte Touche Tohmatsu Limited (“DTTL”), its global network of member firms, and their related entities (collectively, the “Deloitte organization”). DTTL (also referred to as “Deloitte Global”) and each of its member firms and related entities are legally separate and independent entities, which cannot obligate or bind each other in respect of third parties. DTTL and each DTTL member firm and related entity is liable only for its own acts and omissions, and not those of each other. DTTL does not provide services to clients. Please see [www.deloitte.com/de/ueberUns](http://www.deloitte.com/de/ueberUns) to learn more.

Deloitte provides industry-leading audit and assurance, tax and legal, consulting, financial advisory, and risk advisory services to nearly 90% of the Fortune Global 500<sup>®</sup> and thousands of private companies. Legal advisory services in Germany are provided by Deloitte Legal. Our professionals deliver measurable and lasting results that help reinforce public trust in capital markets, enable clients to transform and thrive, and lead the way toward a stronger economy, a more equitable society and a sustainable world. Building on its 175-plus year history, Deloitte spans more than 150 countries and territories. Learn how Deloitte’s approximately 415,000 people worldwide make an impact that matters at [www.deloitte.com/de](http://www.deloitte.com/de).

This communication contains general information only, and none of Deloitte Consulting GmbH or Deloitte Touche Tohmatsu Limited (“DTTL”), its global network of member firms or their related entities (collectively, the “Deloitte organization”) is, by means of this communication, rendering professional advice or services. Before making any decision or taking any action that may affect your finances or your business, you should consult a qualified professional adviser.

No representations, warranties or undertakings (express or implied) are given as to the accuracy or completeness of the information in this communication, and none of DTTL, its member firms, related entities, employees or agents shall be liable or responsible for any loss or damage whatsoever arising directly or indirectly in connection with any person relying on this communication. DTTL and each of its member firms, and their related entities, are legally separate and independent entities.